

QUICK START

Whoa, hold on there. Even if you don't read manuals as a matter of principle, at least read this section to avoid hurting yourself or your equipment.

Connect the MX 22 with the power *off*. Balanced XLR cables are recommended, but if you must convert to 1/4" connectors, buy or make a cable like the ones on page Manual-11 and keep them as short as possible. *This device uses low impedance balanced line drivers. Do not connect the "+" or "-" output pins to ground, as this may cause the power supply to shut down. For unbalanced use, leave the unused output pin ("+" or "-") unterminated.*

Consult the speaker manufacturer for the correct crossover **FREQUENCY** setting. As rugged as some drivers are, many (especially compression drivers) will not accept frequencies outside of their normal range without producing distortion and possibly self-destruction.

With all equipment turned off and **LEVEL** controls down, begin making connections to the system as shown on page Manual-4 or 5. When turning on the system, switch on the power amplifiers *last*. Now, feed the MX 22 some program material. Start by turning up the **LOW LEVEL** and **HIGH LEVEL** to the **0 dB** marks. Slowly increase the **INPUT LEVEL**, even if it goes all the way to **10**, so the **+4 dBu** (green) light blinks occasionally and the **OL** (red) light stays out. This delivers the best signal-to-noise performance.

The **MONO SUB OUTPUT** is a sum of the Left and Right Low Outputs. The **MONO SUB LEVEL** adjusts only this Output and is not affected by the **LOW LEVEL** control.. When using a single subwoofer along with full-range cabinets that have internal crossovers, set the **100 Hz FILTER** to **OUT**, allowing the front panel **FREQUENCY** to control the subwoofer crossover point. When used with biamp cabinets and a subwoofer, set the **100 Hz FILTER** switch to **IN** to allow only frequencies below 100 Hz at this output jack. This way, the MX 22 almost does the job of a Stereo 3-Way crossover, but without removing that awesome bass from the Left and Right Low Outputs.

IMPORTANT SAFETY INSTRUCTIONS



1. Read these instructions.
 2. Keep these instructions.
 3. Heed all warnings.
 4. Follow all instructions.
 5. Do not use this apparatus near water.
 6. Clean only with a dry cloth.
 7. Do not block any ventilation openings. Install in accordance with manufacturer's instructions.
 8. Do not install near any heat sources such as radiators, registers, stoves, or other apparatus (including amplifiers) that produce heat.
 9. Do not defeat the safety purpose of the polarized or grounding-type plug. A polarized plug has two blades with one wider than the other. A grounding-type plug has two blades and a third grounding prong. The wide blade or third prong is provided for your safety. If the provided plug does not fit into your outlet, consult an electrician for replacement of the obsolete outlet.
 10. Protect the power cord and plug from being walked on or pinched particularly at plugs, convenience receptacles, and the point where it exits from the apparatus.
 11. Only use attachments and accessories specified by Rane.
 12. Use only with the cart, stand, tripod, bracket, or table specified by the manufacturer, or sold with the apparatus. When a cart is used, use caution when moving the cart/apparatus combination to avoid injury from tip-over.
 13. Unplug this apparatus during lightning storms or when unused for long periods of time.
 14. Refer all servicing to qualified service personnel. Servicing is required when the apparatus has been damaged in any way, such as power supply cord or plug is damaged, liquid has been spilled or objects have fallen into the apparatus, the apparatus has been exposed to rain or moisture, does not operate normally, or has been dropped.
 15. The plug on the power cord is the AC mains disconnect device and must remain readily operable. To completely disconnect this apparatus from the AC mains, disconnect the power supply cord plug from the AC receptacle.
 16. This apparatus shall be connected to a mains socket outlet with a protective earthing connection.
 17. When permanently connected, an all-pole mains switch with a contact separation of at least 3 mm in each pole shall be incorporated in the electrical installation of the building.
 18. If rackmounting, provide adequate ventilation. Equipment may be located above or below this apparatus, but some equipment (like large power amplifiers) may cause an unacceptable amount of hum or may generate too much heat and degrade the performance of this apparatus.
 19. This apparatus may be installed in an industry standard equipment rack. Use screws through all mounting holes to provide the best support.
- WARNING:** To reduce the risk of fire or electric shock, do not expose this apparatus to rain or moisture. Apparatus shall not be exposed to dripping or splashing and no objects filled with liquids, such as vases, shall be placed on the apparatus.

NOTE: This equipment has been tested and found to comply with the limits for a Class B digital device, pursuant to part 15 of the FCC Rules. These limits are designed to provide reasonable protection against harmful interference in a residential installation. This equipment generates, uses and can radiate radio frequency energy and, if not installed and used in accordance with the instructions, may cause harmful interference to radio communications. However, there is no guarantee that interference will not occur in a particular installation. If this equipment does cause harmful interference to radio or television reception, which can be determined by turning the equipment off and on, the user is encouraged to try to correct the interference by one or more of the following measures:

- Reorient or relocate the receiving antenna.
- Increase the separation between the equipment and receiver.
- Connect the equipment into an outlet on a circuit different from that to which the receiver is connected.
- Consult the dealer or an experienced radio/TV technician for help.

CAUTION: Changes or modifications not expressly approved by Rane Corporation could void the user's authority to operate the equipment.

This Class B digital apparatus complies with Canadian ICES-003.

Cet appareil numérique de la classe B est conforme à la norme NMB-003 du Canada.

WARNING

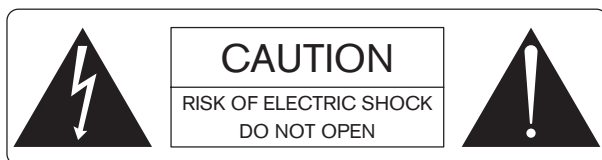

To reduce the risk of electrical shock, do not open the unit. No user serviceable parts inside. Refer servicing to qualified service personnel.

The symbols shown below are internationally accepted symbols that warn of potential hazards with electrical products.



This symbol indicates that a dangerous voltage constituting a risk of electric shock is present within this unit.



This symbol indicates that there are important operating and maintenance instructions in the literature accompanying this unit.

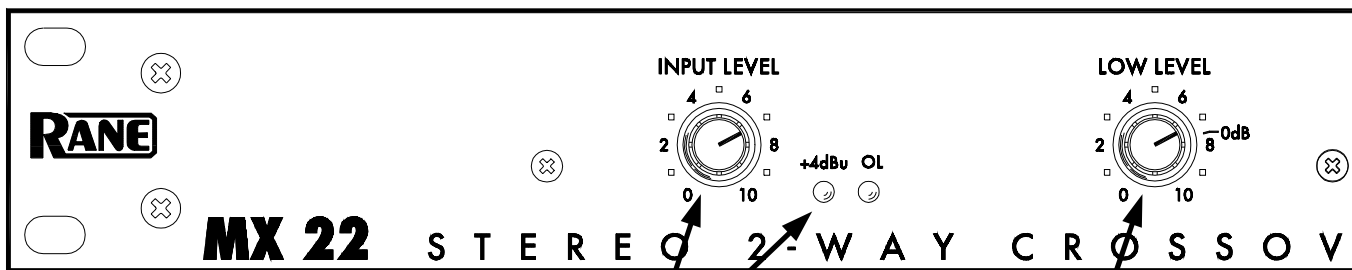

INPUT LEVEL control and indicators

This controls the overall level without altering the relative settings of the Low and High frequency Outputs. Input gain is +6 dB at "10". With signal applied, set this control so the +4 dBu LED lights occasionally, indicating sufficient signal. Flashing of the OL (overload) LED during peaks can be avoided by turning the INPUT LEVEL down.

LOW LEVEL control

This controls the level of signal going to the LOW OUTPUT jacks. Unity gain is reached at the "0 dB" mark with the INPUT LEVEL set to "10". This control does not affect the MONO SUB OUTPUT level. Refer to Operating Instructions on page Manual-6.

MONO SUB OUTPUT, LEVEL trim, and 100 Hz FILTER switch

This Output contains the summed signals of the LEFT and RIGHT LOW OUTPUTS. It may be used instead of, or along with the LOW OUTPUTS. The output may be adjusted with the LEVEL trim from +6 dB to -10 dB. Unity Gain is straight up at 12:00. Switch the 100 Hz FILTER to IN when using a subwoofer along with the LOW OUTPUTS. This sends only the very lowest frequencies to the subwoofer.

HIGH OUTPUTS

These are balanced Output jacks. Connect the LEFT HIGH OUTPUT to the left channel input of the high frequency amplifier, and the RIGHT HIGH OUTPUT to the right channel input of the high frequency amplifier. When using different model amplifiers for the low and high outputs, use the amplifier with the most power for the low outputs.

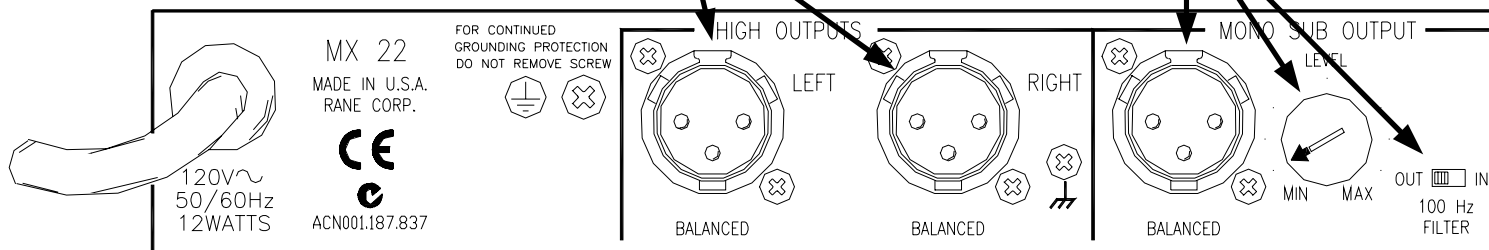

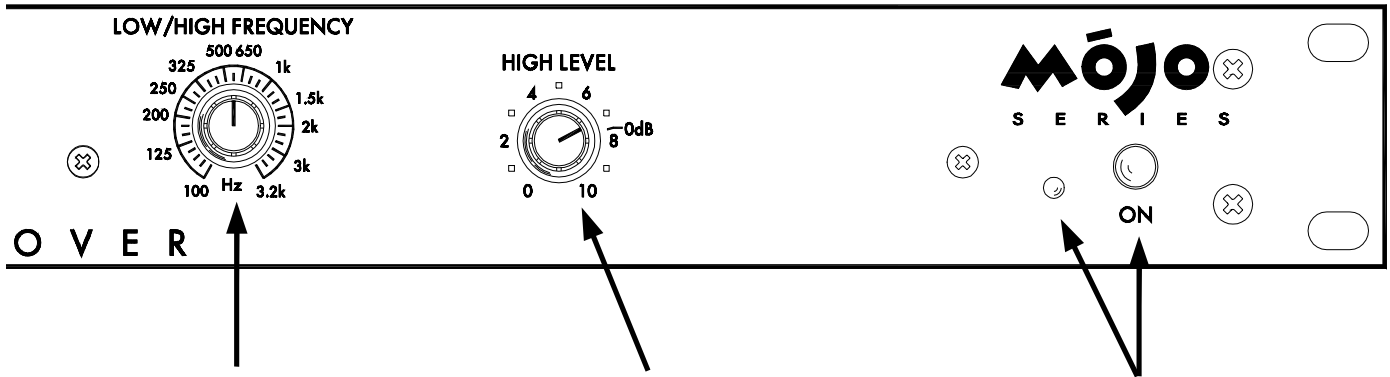

LOW/HIGH FREQUENCY control

This 31-position selector sets the crossover frequency between the Low and High frequency Outputs in both Channels. Consult the manufacturer of the drivers or cabinets for the correct setting.

HIGH LEVEL control

This controls the level of signal going to the HIGH OUTPUT jacks. Unity gain is reached at the "0 dB" mark with the INPUT LEVEL set to "10". Refer to Operating Instructions on page Manual-6.

Power ON switch and LED

Your basic, straightforward power switch. When the yellow LED is lit, the MX 22 is ready to go.

LOW OUTPUTS

Connect the LEFT LOW OUTPUT to the left channel of the low frequency amplifier, and the RIGHT LOW OUTPUT to the right channel of the low amplifier. When driving a single subwoofer, use the MONO SUB OUTPUT jack instead.

INPUTS

These are balanced Inputs. It is best to use balanced lines, especially when connecting cables over 10 feet in length. If you are feeding the MX 22 from a device that does not have balanced XLR connectors, consult SOUND SYSTEM INTERCONNECTION on page Manual-10.

Cable Wiring

In agreement with IEC and AES/ANSI standards, Rane wiring convention is pin 2 Positive (hot), pin 3 Negative (cold or return), and pin 1 signal grounded and chassis grounded (to allow unbalanced operation). The XLR case is chassis grounded. *This device uses low impedance balanced line drivers. Do not connect the "+" or "-" output pins to ground, as this may cause the power supply to shut down. For unbalanced use, leave the unused output pin ("+" or "-") unterminated.*

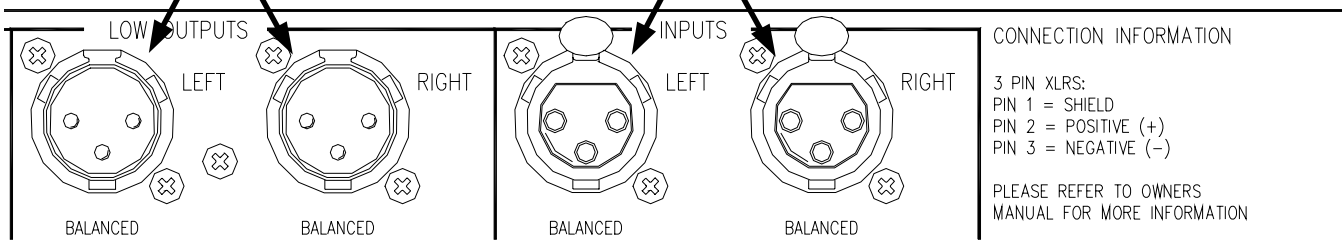

APPLICATION — ACTIVE 2-WAY WITH (or without) MONO SUB

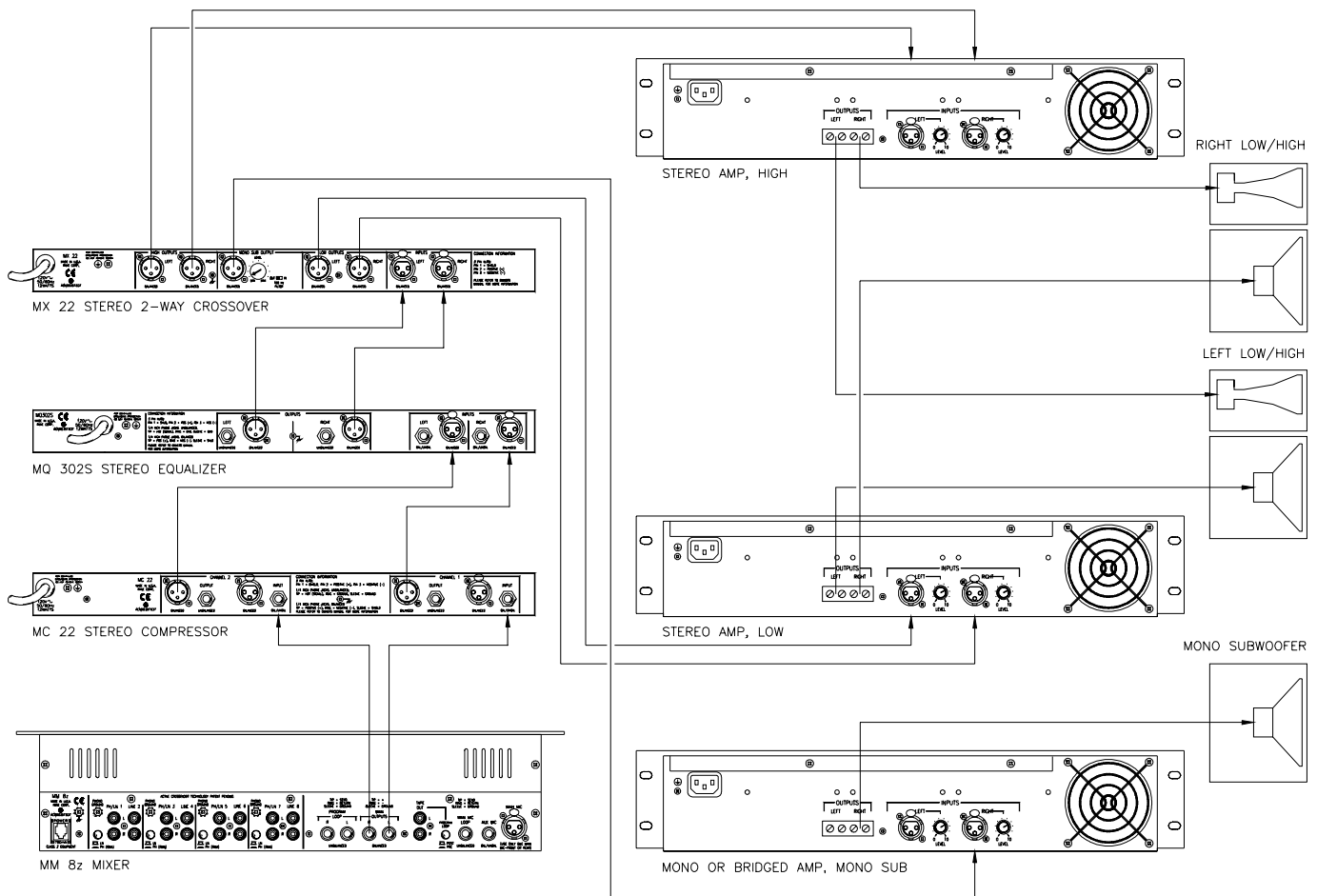

Use this configuration if you have separate speaker inputs for the low and high drivers, regardless of whether they are in the same or different cabinets.

Connect as shown for a mono subwoofer. Set the 100 Hz FILTER switch to the IN position. If a mono subwoofer is not used, the FILTER switch setting will not matter, since all low frequencies will be sent to the LEFT and RIGHT LOW OUTPUTS.

The front panel LOW/HIGH FREQUENCY control determines the frequency division between the low and high drivers, and only low frequencies below 100 Hz will be sent to the mono subwoofer.

APPLICATION — PASSIVE 2-WAY WITH MONO SUB

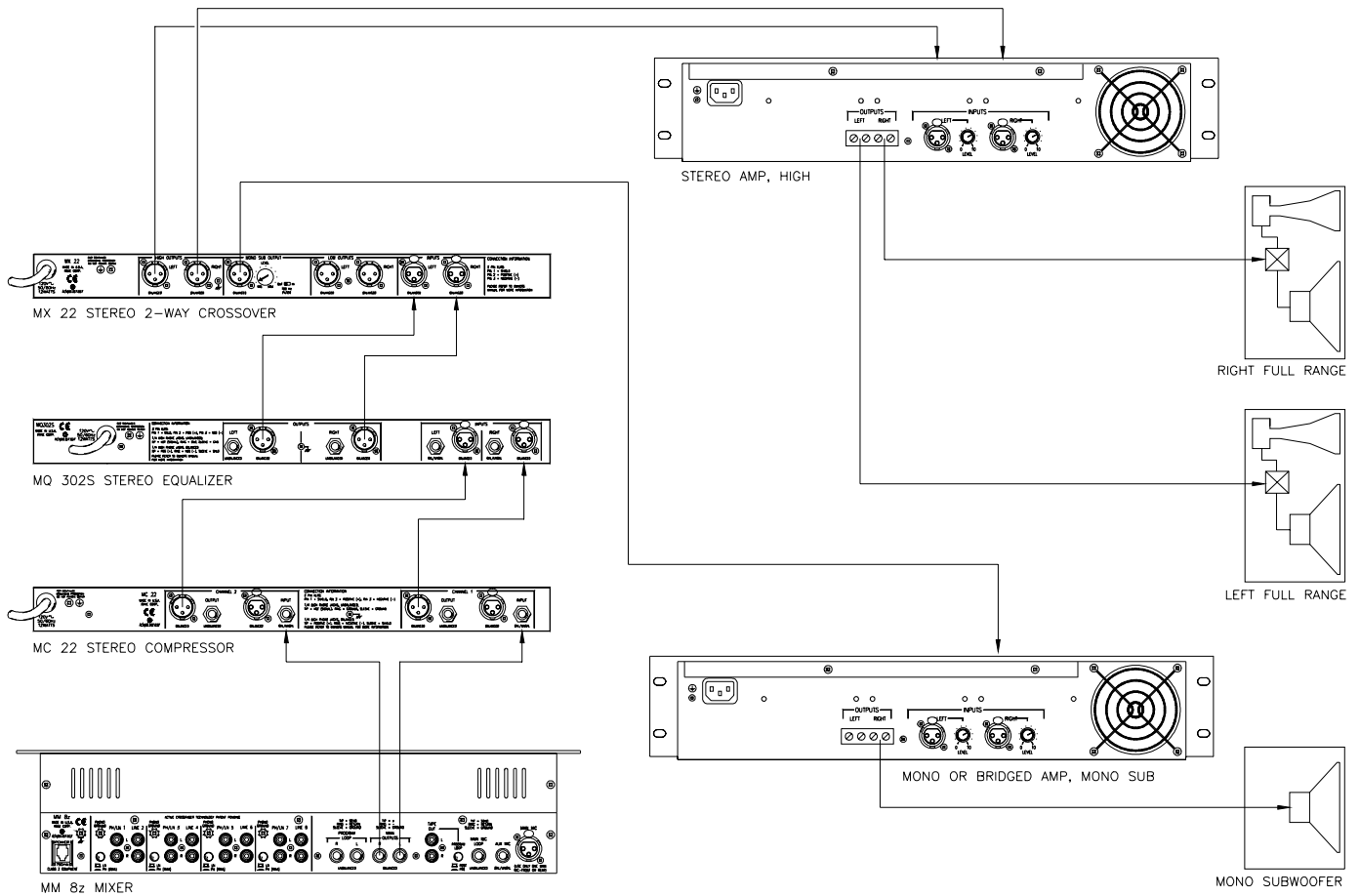

Use this configuration if you have full-range cabinets with passive crossovers built-in, i.e., no separate speaker inputs for the low and high drivers.

Connect as shown for a mono subwoofer. Set the 100 Hz FILTER switch to the OUT position. The front panel LOW/HIGH frequency control determines the frequency division between the main cabinets and the mono subwoofer.

OPERATING INSTRUCTIONS

Selecting Crossover Frequencies

Most speaker manufacturers supply low and/or high frequency cut-off points for each driver, especially if these are supplied in a system. These cut-off frequencies are based on each driver's performance, with a certain safety margin to accommodate more gentle filter roll-offs.

The MX 22 utilizes a 31-position precision DC control voltage potentiometer to select the LOW/HIGH FREQUENCY point. This crossover circuit design assures consistent accuracy from Channel-to-Channel and unit-to-unit. This is a distinct advantage over continuously variable designs using ganged potentiometers which can yield large variations in channel-to-channel matching. Even with 31 choices it is possible that the exact recommended Crossover Frequency may not fall on one of the detents on the selector. Not to panic, for drivers have their own gradual rolloffs and tolerance variations. Just pick the closest one. When in doubt, choose the higher Frequency setting.

The illustration and table below details the crossover frequencies available on the detents that are not labeled. For best overall system results, try to choose the speaker components so that each operates well within its recommended limits. This provides valuable leeway so that crossover points may be adjusted in order to fine-tune the system. This also yields higher system reliability. If at all possible, always use some kind of realtime analyzer to tune your crossover, and then fine-tune each system with an equalizer. Keep reading for further alignment details.

LOW/HIGH FREQUENCY

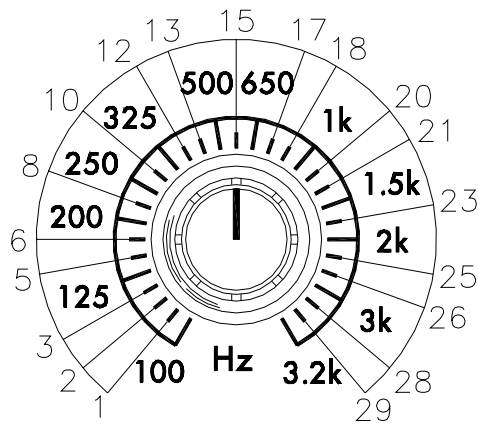

Figure 1. See unmarked Frequency detent steps below.

STEP	0	1	2	3	4	5	6	7	8	9	10	11	12	13	14	15	16	17	18	19	20	21	22	23	24	25	26	27	28	29	30
SILK SCREEN	100				125			200		250					500		650				1000			1500	2000			3000			3200
CALC. FREQ.	100	100	100	107	123	141	162	187	214	246	283	325	373	429	492	566	650	746	857	985	1131	1300	1493	1715	1970	2263	2599	2986	3200	3200	3200

Figure 2. Frequency detent table with actual frequencies of all detent steps.

Setting the Output Level Controls

The INPUT LEVEL is an overall system sensitivity adjustment. Use this control to decrease the overall sensitivity of the entire sound system, including the mono subwoofer if you are using one. You will generally want to start with this control in the full clockwise (or 10) position.

The LOW LEVEL, HIGH LEVEL and MONO SUB OUTPUT LEVEL controls allow you to compensate for sensitivity variations in amplifiers and drivers. Do not use these to adjust overall system sensitivity unless you plan to re-align the system afterward. With these set to the 0 dB mark and the INPUT LEVEL set to 10, the crossover yields no level change from input to output. This is the best gain structure and provides the best signal-to-noise performance.

Crossover Philosophy

Now it gets real fun. The idea is to set the output LEVEL controls on the crossover so that the entire speaker system has a uniform, flat response. Unfortunately, the room in which the speakers are placed has a habit of always getting into the act, so things get messy. As a result there seems to be two schools of thought regarding the use of active crossovers.

The Set-It-Once-And-Glue-It School

The philosophy here is to use the crossover to flatten system response as much as possible *without* room acoustics involved. This means setting up the system outside (unless you happen to have a *very* large anechoic chamber handy) and with the aid of a realtime analyzer and pink noise source, adjust all of the crossover outputs so that the system is as flat as possible. Once the system is tuned, the crossover is then locked behind a security cover (posted guard is optional) and never again touched. It is then the job of the system *equalizer(s)* to normalize or flatten the response for each different room.

The Fix-It-With-The-Crossover School

Here the crossover knobs get a good workout, for the crossover is used at each location to help flatten the system along with the equalizer.

Regardless of which school you profess, the absolute importance and effectiveness of some kind of realtime analyzer in your system cannot be overstressed! An analyzer saves tremendous amounts of time and provides the absolute consistency, accuracy, and plain old good sound that very few ears on this earth can deliver. They are affordable, easy to use and amazingly effective. You owe it to yourself and your audience to at least look into one of today's cost-effective analyzers—you'll wonder how you managed at all without one.

Setting the Mono Sub Output Level

Begin with the MONO SUB OUTPUT LEVEL trim set at MAX. The LOW LEVEL control has no effect on the MONO SUB OUTPUT. Make subwoofer level changes with either the MONO SUB OUTPUT LEVEL or with the amplifier level control. If you are using the MONO SUB OUTPUT *instead of* the LOW OUTPUTS, be sure the 100 Hz FILTER is switched OUT.

Setting Levels With a Realtime Analyzer

Any good 1/3-octave realtime analyzer will do, however, Rane makes a rather inexpensive yet accurate one—the RA 27. We had to get our plug in.

1. Set the INPUT LEVEL as described previously on page Manual-2, and the LOW and HIGH LEVEL controls to minimum; leave the FREQUENCY control as it was set previously.
2. Place the analyzer microphone at least 15 feet away from the speaker stack, on axis (dead ahead) and about chest level. Minimize any background noise (fans, air conditioners, traffic, wild animals, etc.) that could affect readings.
3. Run pink noise through the system, either through a mixer channel or directly into the crossover. Turn all amplifier controls at least half way up.
4. Slowly turn up the LOW LEVEL control until you hear a healthy level of noise through the low frequency drivers (it should sound like rumble).
4. Adjust the display controls on the analyzer so that it shows the greatest number of 0 dB LED's (green on Rane equipment) below the crossover frequency.
6. Now slowly turn up the HIGH LEVEL control until the display shows the same high frequency output level average as the low frequency section.

IMPORTANT: Compression driver or horn high frequency roll-off, bass roll-off, and room acoustics usually cannot be corrected by the crossover.

If, for example, you are adjusting the HIGH FREQUENCY LEVEL control and observe a decline in frequency response somewhat above the Crossover point, then set the HIGH LEVEL control for equal display level near the crossover point and leave it there. Use an equalizer to correct the roll-off problem.

If you are tuning the system in a room, the acoustics will greatly influence the system response, as shown by the analyzer.

Move the microphone and check the analyzer system response at several other locations. Adjust the crossover to reach a fixed compromise setting as necessary. If you plan to use the analyzer only once to set the crossover, set up the speaker system in a quiet place *outside* or in a very large concert theater, and run pink noise at low levels with closer microphone placement to keep the room acoustics out of the picture as much as possible.

Setting Levels Using an SPL Meter and Pink Noise Generator

First, obtain a good SPL meter from a local electronics or hi-fi store. Second, and perhaps a little trickier, get a pink noise generator—again try electronics stores. You may also use a sweep or tone generator in place of a pink noise source—be sure to look at several different tones within each crossover section to get a good average of driver response.

1. Run pink noise into the crossover Inputs (through the mixer or directly, as is convenient).
2. Make sure all crossover LEVEL(s) are turned all the way down and all amplifier level controls are at least half way up to start with.
3. Turn the crossover INPUT LEVEL all the way up. Place the SPL meter at least 15 feet from the speaker stack and about chest high. Once positioned, make sure that the SPL meter remains in the *exact* same location for the rest of the procedure. Minimize all background noise (fans, air conditioners, traffic, wild animals, etc.) to get accurate readings. Set the SPL meter to “C-weighting” and “slow” if those switches are present.
4. Slowly turn the LOW LEVEL up until there is a healthy rumble coming from the bass speakers. Adjust the SPL meter and/or LOW LEVEL until you get a 0 dB reading on the meter. *After this point do not change the controls on the SPL meter.*
5. Make a note of the LOW LEVEL control setting at the 0 dB adjustment just obtained, then reduce the LOW LEVEL to “0” so that the pink noise disappears from the bass speakers (revel in the silence...).
6. Now slowly turn up the HIGH LEVEL control so that pink noise is heard from the high frequency speakers. Without changing any settings on the SPL meter, adjust the crossover HIGH LEVEL control until you obtain a 0 dB reading on the SPL meter.
7. Return the LOW LEVEL to the previously recorded setting. Now the low and high speakers are set at the same level. The crossover should now be aligned. Make any overall level adjustments with the INPUT LEVEL controls and leave the output LOW and HIGH LEVEL controls unchanged.

It is possible that you may turn one of the frequency section output LEVEL controls all the way up and still not have enough volume for a 0 dB reading (as determined by previous section levels). This is probably due to different sensitivities of amps, speakers and other level controls in the system. When this happens, re-set the SPL meter so that it reads 0 dB on this frequency section (you may have to “down range” the meter and re-adjust the crossover INPUT LEVEL control). Now go back and re-adjust the previous crossover LEVEL controls, turning these down to get a 0 dB reading on the meter.

SOUND SYSTEM INTERCONNECTION

Rane's policy is to accommodate rather than dictate. However, this document contains suggestions for external wiring changes that should ideally only be implemented by trained technical personnel. Safety regulations require that all original grounding means provided from the factory be left intact for safe operation. No guarantee of responsibility for incidental or consequential damages can be provided. (*In other words, don't modify cables, or try your own version of grounding unless you really understand exactly what type of output and input you have to connect.*)

THE ABSOLUTE BEST RIGHT WAY TO DO IT

Use balanced lines and *tie the cable shield to the metal chassis (right where it enters the chassis) at both ends of the cable.*

A balanced line requires three separate conductors, two of which are signal (+ and -) and one shield. The shield serves to guard the sensitive audio lines from interference. Only by using balanced line interconnects can you *guarantee* (yes, *guarantee*) hum-free results. Always use twisted pair cable. Chassis tying the shield at each end also *guarantees* the best possible protection from RFI [radio frequency interference] and other noises [neon signs, lighting dimmers].

THE NEXT BEST RIGHT WAY TO DO IT

The quickest, quietest and most foolproof method to connect balanced and unbalanced is to **transformer isolate all unbalanced connections**. Your audio dealer can recommend such a transformer.

The goal of transformer adaptors is to allow the use of *standard cables*. With these transformer isolation boxes, modification of cable assemblies is unnecessary. Virtually any two pieces of audio equipment can be successfully interfaced without risk of unwanted hum and noise.

Another way to create the necessary isolation is to use a *direct box*. Originally named for its use to convert the high impedance, high level output of an electric guitar to the low impedance, low level input of a recording console, it allowed the player to plug "directly" into the console. Now this term is commonly used to describe any box used to convert unbalanced lines to balanced lines.

THE LAST BEST RIGHT WAY TO DO IT

If transformer isolation is not an option, special cable assemblies are a last resort. The key here is to prevent the shield currents from flowing into a unit whose grounding scheme creates ground loops (hum) in the audio path (i.e., most audio equipment). Do not be tempted to use 3-prong to 2-prong "cheater" adapters to lift grounds. This is a dangerous and illegal practice.

It is true that connecting both ends of the shield is theoretically the best way to interconnect equipment – though this assumes the interconnected equipment is internally grounded properly. Since most equipment is *not* internally grounded

properly, connecting both ends of the shield is not often practiced, since doing so can create noisy interconnections.

A common solution to these noisy hum and buzz problems involves disconnecting one end of the shield, even though one can not buy off-the-shelf cables with the shield disconnected at one end. The best end to disconnect is a matter of personal preference and should be religiously obeyed; choose inputs or outputs and always lift the side you choose (our drawings happen to disconnect the outputs). If one end of the shield is disconnected, the noise current stops flowing and away goes the hum — but only at low frequencies. A one-end-only shield connection increases the possibility of high frequency (radio) interference since the shield may act as an antenna. Many reduce this potential RF interference by providing an RF path through a small capacitor (0.1 or 0.01 microfarad ceramic disc) connected from the lifted end of the shield to the chassis. The fact that many modern day installers still follow this one-end-only rule with consistent success indicates this and other acceptable solutions to RF issues exist, though the increasing use of digital and wireless technology greatly increases the possibility of future RF problems.

See the following page for suggested cable assemblies for your particular interconnection needs. Find the appropriate output configuration from either your mixer output or the MX 22 output (down the left side), and then match this with the correct balanced or unbalanced input to the MX 22 or the amplifier (down the right side.) An "off-the-shelf" cable may be available or modifiable. Soldering should only be attempted by those trained in the art.

SUMMARY

If you are unable to do things correctly (i.e. use fully balanced wiring with shields tied to the *chassis* at the point of entry, or transformer isolate all unbalanced signals from balanced signals) then there is no guarantee that a hum free interconnect can be achieved, nor is there a definite scheme that will assure noise free operation in all configurations.

WINNING THE WIRING WARS

- Use balanced connections whenever possible.
- Transformer isolate all unbalanced connections from balanced connections.
- Use special cable assemblies when unbalanced lines cannot be transformer isolated.
- Any unbalanced cable must be kept under ten feet (three meters) in length. Lengths longer than this will amplify the nasty side effects of unbalanced circuitry's ground loops.

This information was condensed from Rane Note 110, "Sound System Interconnection". If you would like the complete note, call or email the factory, download it from Rane's web site (addresses on the rear of this manual), or ask your dealer for a copy.

VARIOUS XLR CABLE ASSEMBLIES

T
 U
 P
 T
 U
 O
 M
 O
 R
 E

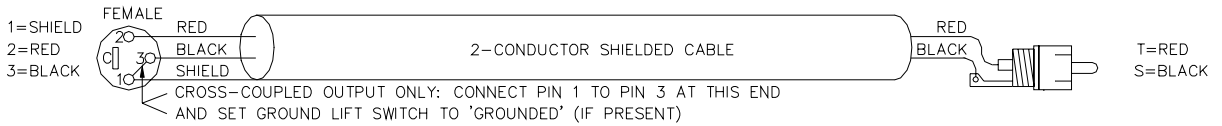
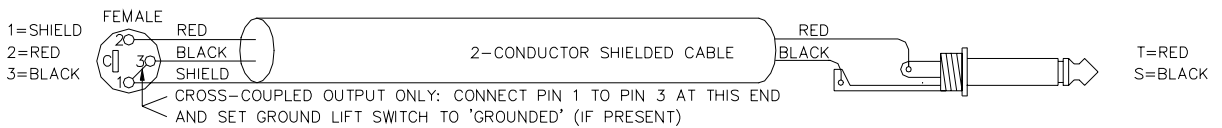
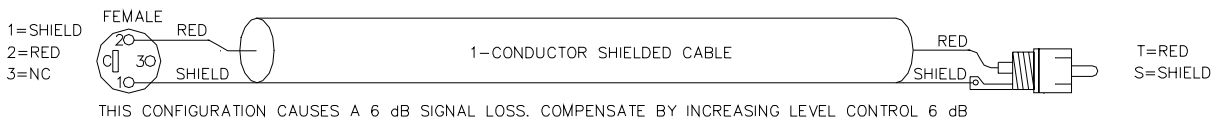

"OFF THE SHELF" STANDARD CABLE

MOJO GLOSSARY

balanced line The recommended method of interconnecting audio equipment. A balanced line requires three conductors: a twisted-pair for the signal (positive and negative) and an overall shield. *The shield must be tied to the chassis at both ends for hum-free interconnect.*

bandwidth *Abbr. BW* The numerical difference between the upper and lower -3 dB points of an audio band.

clipping What occurs when a unit tries to produce a signal *larger than its power supply*. The signal takes on a flat-topped, or *clipped* shape. When an amplifier tries to go above its max power, it *clips*.

compressor A signal processing device used to *reduce the dynamic range* of the signal passing through it. For instance, an input dynamic range of 110 dB might pass through a compressor and exit with a new dynamic range of 70 dB. The modern usage for compressors is to turn down (or reduce the dynamic range of) just the loudest signals. Other applications use compressors to control the *creation* of sound. When used in conjunction with microphones and musical instrument pick-ups, compressors help determine the final timbre by selectively compressing specific frequencies and waveforms.

connectors Audio equipment uses different styles:

RCA An *unbalanced* pin connector commonly used on consumer and some pro equipment; aka *phono plug*

XLR A 3-pin connector common on pro audio equipment.

Preferred for *balanced line* interconnect; aka *Cannon plug*

¼" TRS 1. *Stereo* ¼" connector consisting of *tip* (T), *ring* (R), and *sleeve* (S) sections, with T = *left*, R = *right*, and S = *ground/shield*. 2. *Balanced* interconnect with the pos & neg signal lines tied to T and R respectively and S acting only as an overall shield. 3. *Insert loop* interconnect with T = *send*, R = *return*, and S = *ground/shield*. [Think: *ring, right, return*]

¼" TS *Mono* ¼" connector consisting of *tip* (T) [signal] and *sleeve* (S) [ground & shield] for *unbalanced* wiring.

constant-Q equalizer (also **constant-bandwidth**) The bandwidth remains constant for all boost/cut levels. Since Q and bandwidth are interrelated, the terms are fully interchangeable.

decibel *Abbr. dB* (named after *Alexander Graham Bell*). The preferred method and term for representing the *ratio* of different audio levels. Being a ratio, *decibels have no units*. Everything is relative. So it must be relative to some *0 dB reference point*. A suffix letter is added to distinguish between reference points:

0 dBu A reference point equal to 0.775 V

+4 dBu Standard pro reference level equal to 1.23 V

0 dBV A reference point equal to 1.0 V

-10 dBV Standard reference level for consumer and some pro audio use, equal to 0.316 V. *RCA* (phono) connectors are a good indicator of units operating at -10 dBV

dynamic range The ratio of the loudest signal to the quietest signal in a unit or system as expressed in *decibels* (dB).

expander A signal processing device used to *increase the dynamic range* of the signal passing through it. Expanders complement compressors. For example, a compressed input dynamic range of 70 dB might pass through an expander and exit with a new *expanded* dynamic range of 110 dB. Modern expanders usually operate only *below a set threshold point*, i.e., they operate only on low-level audio. The term *downward expander* describes this type of application.

ground Any electrical reference point for measuring voltage levels. Usually a large conducting body, such as the earth or an electric circuit connected to the earth. Chassis should always be at earth potential. **WARNING: SHOCK HAZARD**

Never use an AC line cord ground-lift adapter or cut off the 3rd pin. It is illegal and dangerous.

headroom The level in dB between the typical operating level and *clipping*. For example, a nominal +4 dBu system that clips at +20 dBu has 16 dB of *headroom*.

hum Unwanted sound contaminating audio paths due to EMI (electro-magnetic interference) caused by AC power-lines & transformers getting into unbalanced, poorly shielded, or improperly grounded connecting cables. Hum has a definite smooth (sine wave) repetitive sound based on the harmonics of 50/60 Hz such as 100/120 Hz and 150/180 Hz.

interpolating Term meaning to insert between two points. If a graphic equalizer's adjacent bands, when moved together, produce a smooth response without a dip in the center, they are *interpolating* between the fixed center frequencies.

levels Terms used to describe relative audio signal levels:

mic-level Nominal signal coming directly from a microphone.

Very low, in the microvolts, and requires a preamp with at least 60 dB gain before using with any *line-level* equipment.

line-level Standard +4 dBu or -10 dBV audio levels.

instrument-level Nominal signal from musical instruments using electrical pick-ups. Varies widely, from very low *mic-levels* to quite large *line-levels*.

limiter A compressor with a fixed *ratio* of 10:1 or greater. The dynamic action prevents the audio signal from becoming larger than the *threshold* setting.

Linkwitz-Riley crossover The most preferred active crossover design. It features steep 24 dB/octave slopes, in-phase outputs, and flat amplitude response. Due to the in-phase outputs the acoustic lobe resulting when both loudspeakers reproduce the crossover frequency is always on-axis (not tilted up or down) and has no peaking.

noise 1. *Interconnect*. Unwanted sounds contaminating audio paths. RFI (radio frequency interference) caused by broadcast signals leaking into unbalanced, poorly shielded, or improperly grounded connecting cables. Also by light dimmers, motor controls and computers. 2. *Music*. A random mix of audio frequencies not harmonically related, sounding like radio static.

polarity A signal's electromechanical potential with respect to a reference. For example, a microphone has *positive polarity* if a positive pressure on its diaphragm results in a positive output voltage. **polarity vs. phase shift:** *polarity* refers to a signal's *reference* NOT to its *phase shift*. Being 180 degrees *out-of-phase* and having *inverse polarity* are DIFFERENT things. We wrongly say something is *out-of-phase* when we mean it is *inverted*. One occurs over a period of *time*; the other occurs instantaneously.

Q (upper-case) Quality factor. Defined to be the ratio of the center frequency *f* divided by the bandwidth *BW* for a bandpass filter.

signal-to-noise ratio The ratio in dB between a reference level and the noise floor. For example, a signal-to-noise ratio of 90 dB re +4 dBu, means the noise floor is 90 dB below a +4 dBu ref.

unbalanced line An audio interconnect scheme using one wire with an overall shield. The shield must perform two functions: act as the return signal path (*ground*) and to protect the conductor from noise (*shield*). Consequently this method is vulnerable to hum & noise problems.

unity gain A gain setting of one. The level out equals the level in.