

# KENWOOD

sovereign

## Connection and Setup Guide

How To Connect And Set Up Your

**VR-5700**

**VR-5090**

**VR-5080**

Digital Audio/Video Receiver

# Before Applying Power

*Read this section carefully to ensure safe operation.*

VR-5700/VR-5090/VR-5080 is designed for operation as follows.





**U.S.A. and Canada ..... AC 120 V only**

## ii Safety Precautions

*Read this section carefully to ensure safe operation.*

### **WARNING :**

TO PREVENT FIRE OR ELECTRIC SHOCK, DO NOT EXPOSE THIS APPLIANCE TO RAIN OR MOISTURE.

  	CAUTION: TO REDUCE THE RISK OF ELECTRIC SHOCK, DO NOT REMOVE COVER (OR BACK). NO USER-SERVICEABLE PARTS INSIDE. REFER SERVICING TO QUALIFIED SERVICE PERSONNEL.
	THE LIGHTNING FLASH WITH ARROWHEAD SYMBOL, WITHIN AN EQUILATERAL TRIANGLE, IS INTENDED TO ALERT THE USER TO THE PRESENCE OF UNINSULATED "DANGEROUS VOLTAGE" WITHIN THE PRODUCT'S ENCLOSURE THAT MAY BE OF SUFFICIENT MAGNITUDE TO CONSTITUTE A RISK OF ELECTRIC SHOCK TO PERSONS.
	THE EXCLAMATION POINT WITHIN AN EQUILATERAL TRIANGLE IS INTENDED TO ALERT THE USER TO THE PRESENCE OF IMPORTANT OPERATING AND MAINTENANCE (SERVICING) INSTRUCTIONS IN THE LITERATURE ACCOMPANYING THE APPLIANCE.

# Connecting and Setting Up Your New Kenwood Audio-Video Receiver

Welcome to the Connection and Setup Guide for your new Kenwood audio-video receiver. This manual covers three models.

The VR-5700/VR-5090/VR-5080 offers 3 kinds of 5.1-channel digital surround sound decoding:

- Dolby Digital, for the hundreds of currently available Dolby Digital DVDs and LaserDiscs.
- DTS, a well-established multichannel format in movie theaters, is available for home theater on LaserDisc and DVD.
- MPEG Multichannel, a well-established multichannel format in movie theaters, is available for home theater on LaserDisc and DVD.

The VR-5700/VR-5090/VR-5080 also offers 2 kinds of 6.1-channel digital surround sound decoding:

- THX Surround EX technology reproduces a surround back channel from software which has been specially encoded with Surround EX.
- DTS-ES also creates a 6.1-channel surround environment by adding the surround back signal. The VR-5700/VR-5090/VR-5080 can handle both DTS-ES Discrete 6.1 featuring recording of all channels in the digital discrete format and DTS-ES Matrix 6.1 featuring matrix encoding.

In addition, the VR-5700/VR-5090/VR-5080 offers the following surround features.

- DTS-NEO:6: This converts 2-channel signals into 6.1-channel signals by means of a high-accuracy digital matrix decoder.
- Dolby Pro Logic II: This advanced version of Dolby Pro Logic features improved audio quality and a dedicated music mode that reproduces conventional 2-channel music in 5.1-channel surround sound.

- THX Mode: Several technologies developed by Lucasfilm® that compensate for playing a film soundtrack in a small room (such as in a home), rather than in a large theater (for which it was originally mixed). The THX Mode compensates for overly bright-sounding soundtracks, creates a more spacious surround sound environment and smooths sound movement from speaker to speaker.

The VR-5700 is a receiver based on the THX Ultra standard and the VR-5090 and VR-5080 are receivers based on the THX Select standard. All of these models are certified by Lucasfilm.

32-Bit DRIVE III: Exclusive Kenwood technology that reproduces digital signals with ultra high resolution. Incorporating a high-performance DSP, 32-Bit DRIVE III significantly reduces digital distortion to reproduce stereo audio with extreme faithfulness to the original signal.

HDCD®: This is a new format of high-resolution recording. The VR-5700/VR-5090/VR-5080 is capable of reproducing CDs recorded in the HDCD format with high resolution and wide dynamic range.

Use it to connect all your current audio and video components—the VR-5700/VR-5090/VR-5080 has a variety of connection jacks so you can customize your entertainment setup.

It also includes Kenwood's remarkable LCD Remote Control unit.



Manufactured under license from Dolby Laboratories. "Dolby", "Pro Logic", "Surround EX" and the double-D symbol are trademarks of Dolby Laboratories. Confidential unpublished works. © 1992-1997 Dolby Laboratories. All rights reserved.



Manufactured under license from Digital Theater Systems, Inc. US Pat. No. 5,451,942, 5,956,674, 5,974,380, 5,978,762 and other world-wide patents issued and pending. "DTS", "DTS-ES Extended Surround" and "Neo:6" are trademarks of Digital Theater Systems, Inc. © 1996, 2000 Digital Theater Systems, Inc. All Rights Reserved. iii



THX SURROUND EX

Lucasfilm and THX are registered trademarks of Lucasfilm Ltd.

©Lucasfilm Ltd. & TM. All rights reserved. Surround EX is a jointly developed technology of THX and Dolby Laboratories Inc. and is a trademark of Dolby. Used under authorization.



**HDCD**, HDCD®, High Definition Compatible Digital® and Pacific Microsonics™ are either registered trademarks or trademarks of Pacific Microsonics, Inc. in the United States and/or other countries. HDCD system manufactured under license from Pacific Microsonics, Inc. This product is covered by one or more of the following: IN the USA: 5,479,168, 5,638,074, 5,640,161, 5,808,574, 5,838,274, 5,854,600, 5,864,311, 5,872,531, and in Australia: 669114. Other patents pending.



The above are additional trademarked names appearing in this manual. All other products named are trademarks of their respective companies.



As an ENERGY STAR® Partner, Kenwood Corporation has determined that this products meets the ENERGY STAR® guidelines for energy efficiency. This product can save energy. Saving energy reduces air pollution and lowers utility bills.

---

## Unpacking

Unpack your new receiver carefully and make sure that all the accessories are present:

Remote Control unit

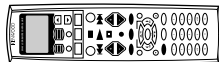

Batteries  
AA (R6) × 4



AM Loop Antenna

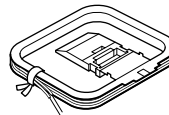

FM Antenna



RF remote Antenna



If any accessories are missing, or if the receiver is damaged or fails to operate, notify your dealer immediately. If your receiver was shipped to you directly, notify your shipper immediately. Kenwood recommends that you retain the original carton and packing materials in case you need to move or ship the receiver in the future.

# Table of Contents

<b>Chapter One: Connecting Your Devices ....</b>			<b>1</b>
<b>Noting Your Devices .....</b>			<b>3</b>
<b>Connecting Your Speakers .....</b>			<b>4</b>
To Connect Front Speakers Only			
To Connect Front and Surround Sound Speakers			
What if I Have a Powered Subwoofer?			
To Connect Surround Back Sound Speakers			
<b>What if I Have an Amplifier? .....</b>			<b>8</b>
<b>Connecting Your TV .....</b>			<b>10</b>
To Connect a TV			
What if I Want to Watch TV without Turning on the Receiver?			
<b>Connecting Your Cable TV or Satellite Tuner .....</b>			<b>12</b>
To Connect a Cable TV Tuner with a Composite (RCA) Video Output			
To Connect a Cable TV Tuner without a Composite (RCA) Video Output			
To Connect a Satellite Tuner			
<b>Connecting Your VCR(s) .....</b>			<b>14</b>
To Connect a Primary VCR			
To Connect a Secondary VCR			
<b>Connecting Your Primary CD Player .....</b>			<b>16</b>
What if I Have a Video CD-Compatible CD Player?			
To Connect a Kenwood 200-Disc CD Changer			
To Connect Any Other Primary CD Player or Changer			
To Connect a Secondary CD Player			
<b>Connecting Your DVD Player .....</b>			<b>18</b>
To Connect a DVD Player			
<b>Connecting Your CD-R Recorder .....</b>			<b>20</b>
To Connect an CD-R Recorder			
<b>Connecting Your MD Recorder or Primary Tape Deck .....</b>			<b>22</b>
To Connect an MD Recorder			
To Connect a Primary Tape Deck			
To Connect a Secondary Tape Deck			
<b>Connecting Your Secondary CD Player or Tape Deck .....</b>			<b>24</b>
To Connect a Secondary CD Player			
To Connect a Secondary Tape Deck			
<b>Connecting Your Laser Disc Player (with AC-3 RF Output) .....</b>			<b>26</b>
To Connect an AC-3 RF Output Laser Disc Player			
<b>Connecting Your Laser Disc Player (without AC-3 RF Output) .....</b>			<b>28</b>
To Connect a PCM Digital Output Laser Disc Player			
<b>Connecting Your Turntable/Record Player .....</b>			<b>30</b>
To Connect a Turntable/Record Player			
<b>Connecting a Camcorder or Additional VCR .....</b>			<b>31</b>
To Connect a Camcorder or Additional VCR			
Can I Connect an Additional VCR Permanently?			
<b>What if I Have Several Kenwood Devices (System Control Chaining)? .....</b>			<b>32</b>
<b>Connecting the Antennas .....</b>			<b>33</b>
RF Remote Antenna			
FM Indoor Antenna			
FM Outdoor Antenna			
AM Loop Antenna			
What if I Have Cable Radio?			
<b>Chapter Two: Setting Up Remote Control Unit .....</b>			<b>34</b>
<b>Installing the Batteries .....</b>			<b>34</b>
<b>Resetting the Remote Control Unit .....</b>			<b>34</b>
<b>Basic Operation of Remote Control Unit .....</b>			<b>35</b>

Table of Contents

**Setting Up Speakers** ..... 36

- Speaker Placement
- Selecting Speakers
- Balancing the Speaker Volumes
- Bass Peak Level
- Adjusting the Speaker Distances

**Identifying Components for Remote Control Unit**  
..... 39

- If a device cannot be remote controlled with any code in the list, or to add remote control target functions...

**Balancing the Speaker Levels with a Sound Level Meter** ..... 42

**vi** **RF Remote Control Function** ..... 43

- Changing the RF Transmission Frequency

**Chapter Three: Using Receiver’s Front Panel to Set Up the Speakers** ..... 44

**Chapter Four: Setting Up Multiple Zones**  
..... 46

**Making Connections** ..... 47

- Scenario 1: Surround Sound in Zone A only/  
Stereo in Zone A and Stereo in Zone B  
(Using the Receiver’s Speaker B Outputs)
- Scenario 2: Surround Sound in Zone A and  
Stereo in Zone B (Using a Stereo Amplifier  
in Zone B)
- Both Scenarios: Connecting a Second TV/  
Monitor

**Connecting the External Infrared Receivers and IR Repeaters** ..... 48

- To connect a Kenwood IR-9991 IR Transceiver
- To connect any other IR Receiver
- To turn the VR-5700, VR-5090 or VR-5080’s RF Receiver off
- To turn the VR-5700, VR-5090 or VR-5080’s RF Receiver back on
- To Connect IR Repeaters

**Chapter Five: Warnings and Specifications**  
..... 50

- Warnings
- VR-5700 Specifications
- VR-5090/VR-5080 Specifications

# Chapter One: Connecting Your Devices

Welcome to the Kenwood VR-5700/VR-5090/VR-5080 Connection and Setup Guide. This chapter guides you through connecting your home entertainment devices to your new Kenwood audio-video receiver.

Once all your devices are connected, you can set up the Remote Control unit (see Chapter Two).

Refer to the following pages for details on connecting these devices:

Speakers	page 4
TV	page 10
VCR(s)	page 14
CD Player, Kenwood 200-Disc Changer	page 16
DVD Player	page 18
CD-R Recorder	page 20
MD Recorder	page 22
Tape Deck(s)	page 26
Laser Disc Player	page 30
Turntable	page 31
Camcorder/Second VCR	page 33
Antennas	



All necessary cables should be provided with your home entertainment device (not with your new receiver). If you do not have the correct cables, you may purchase these cables from any home entertainment store.

To make coaxial digital connections, be sure to use a high-quality digital audio cable, not a standard audio cable.

**Do not** plug in the receiver or any other device to AC power until all connections have been made. Once all devices have been connected, you may plug them in and provide power.

## Important:

Your new receiver requires adequate ventilation to perform reliably. Be sure not to block the ventilation area on the top or back (or both sides) of the receiver with another device. These areas should be:

At least 6 inches (15 cm) from any obstruction.

Do not install your receiver where direct sunlight or high

frequency fluorescent lighting can shine directly into the remote sensor. This can cause your new receiver to malfunction.

## Before You Begin

This manual covers the most common and standard connections to the receiver. Because of its versatility, you may decide to connect your devices differently.

## Video Connections

The **VR-5700/VR-5090** incorporates Kenwood's exclusive Universal Video HD, which converts between composite, S-Video and component video formats. This simplifies operation, and maintains the highest possible video quality while requiring only a single connection between the receiver and your TV. Video format conversion is performed according to the following chart:

Video input signal type	Appears at these video outputs
Composite Video	Composite S-Video Component Video
S-Video	Composite S-Video Component Video
Component Video	Component Video

- Component video connections provide the best video quality; S-Video connections provide video quality that is superior to standard composite video connections. We recommend using the highest quality connection possible between the receiver and your TV.
- Since component video inputs are not downconverted to S-Video or composite video, if you want to record components connected via component video inputs you must also connect that component's S-Video or composite video outputs to the receiver.

The **VR-5080** has three kinds of video input jacks for the Composite video, S-Video and Component video signals.

The signals input at one of these three kinds of jacks can be output at the VIDEO REC OUT and MONITOR OUT jacks of the receiver only in the same signal format as they were input. (This receiver does not incorporate the facility for conversion between video signal formats.)

- If all of your video devices and TV have S-Video jacks, we suggest that you use them exclusively, since it will provide superior video performance.
- If only some of your video devices and TV have S-Video jacks, you can still use them for those devices and the TV. Use the composite jacks for your devices that don't have S-Video jacks. In this case you'll also have to connect the receiver's composite Video Monitor output to your TV for your non S-Video devices.
- If your TV doesn't have S-Video devices, you can't use S-Video connections for any of your video devices. Use the composite jacks exclusively.
- If your video devices and TV have component video jacks, we suggest that you use them exclusively, since it will provide superior S-video performance.
- Each of the video source components connected to the Composite video, S-Video and Component video inputs of the receiver should also be connected to the TV using the same kind of signal connection as it is connected to the receiver.
- It is not possible to record the video from a video source component that is connected to the receiver using only the Component video connection. The source to be recorded should be connected using the Composite video or S-Video connection according to the signal(s) output to the recording component.
- It is not possible to record the video from a video source component which is connected to the receiver using only the S-Video connection to a recording component equipped only with the Composite video input. In this case, both the video source and video recording components should be connected to the receiver using the Composite video connection.

If you plan on using the **VR-5700/VR-5090/VR-5080** in a Dual-Zone application (see Chapter Four), you must use the composite video connections in addition to any component video and S-Video connections for all source components. Only video sources connected to the receiver with composite video connections can be viewed in the second zone.

**The following diagram shows the entire back of the VR-5700/VR-5090/VR-5080.**

2

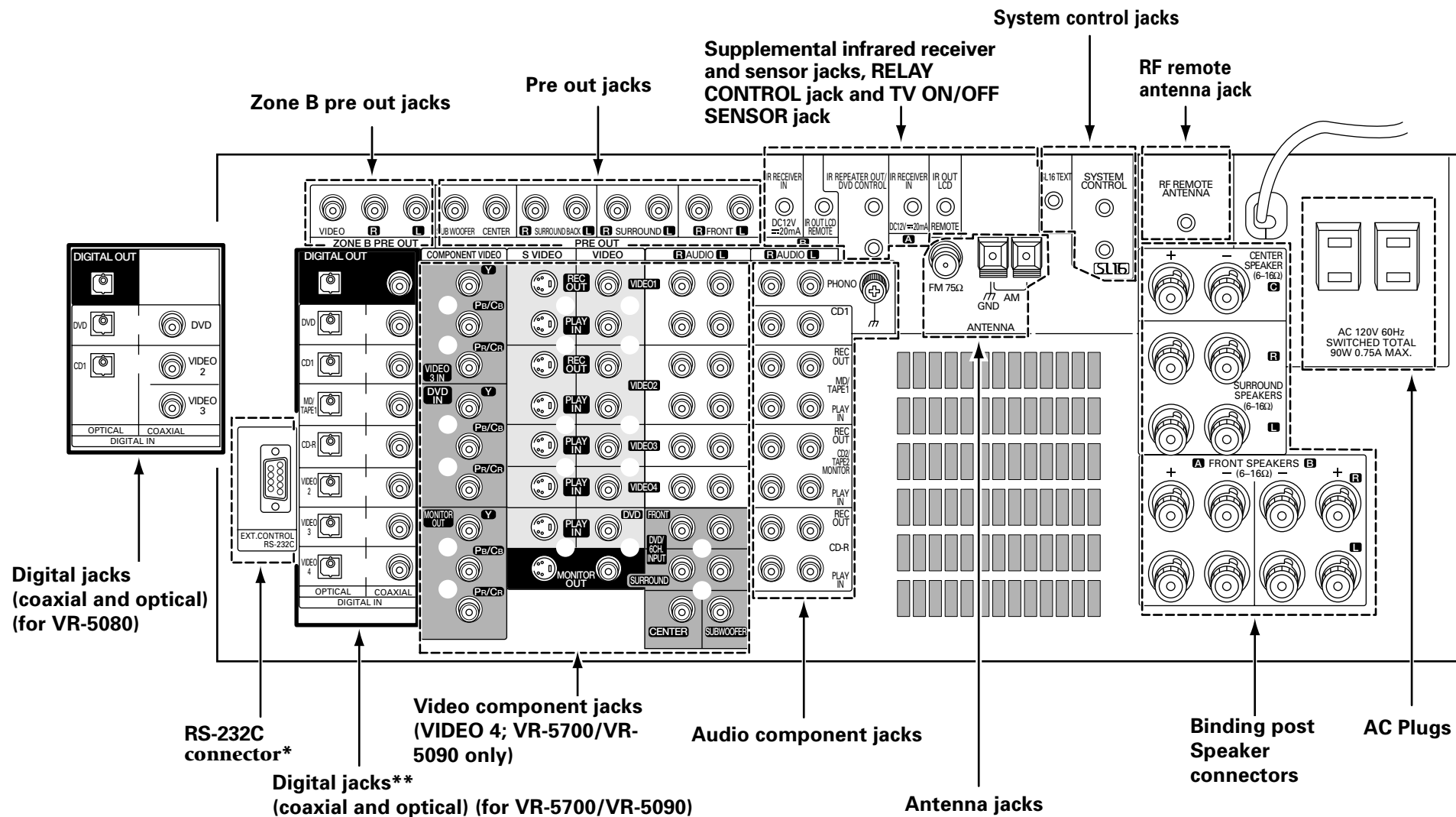

\* The RS-232C connector is provided for future capability (to connect a commercially marketed controller having the capability of controlling the receiver).  
 \*\* Note that the digital input jacks are linked to specific audio and video component jacks. Make sure that each source device is connected to the proper corresponding audio, video and digital jacks.



### Noting Your Devices

Jack Set	Device	Manufacturer	Model #	Setup Code
<b>PHONO</b>				_____
<b>CD1</b>				
<b>MD/TAPE1</b>				
<b>CD2/TAPE2 MONITOR</b>				_____
<b>CD-R</b>				
<b>MONITOR OUT (TV on Remote Control unit)</b>				
<b>VIDEO1</b>				
<b>VIDEO2</b>				
<b>VIDEO3</b>				
<b>VIDEO4 ( VR-5700/ VR-5090 only )</b>				
<b>DVD</b>				

3

Use this table and the diagram on the preceding page to plan your connections before you make them, or use it to record your connections as you make them.

For VR-5080;

If you will be connecting a DVD player or other component with a digital output, please refer to the following chart before choosing a video jack set:

If your digital cable is...	Choose this jack set...
coaxial	DVD, VIDEO2 or 3
optical	DVD

You will need this information later, when you set up your Remote control unit (see "Identifying Components for Remote Control Unit" on page 39). Recording this information now will save you additional trips behind your home entertainment cabinet. You will fill in the Setup Code column when you are setting up Remote control unit.

# Connecting Your Speakers

4

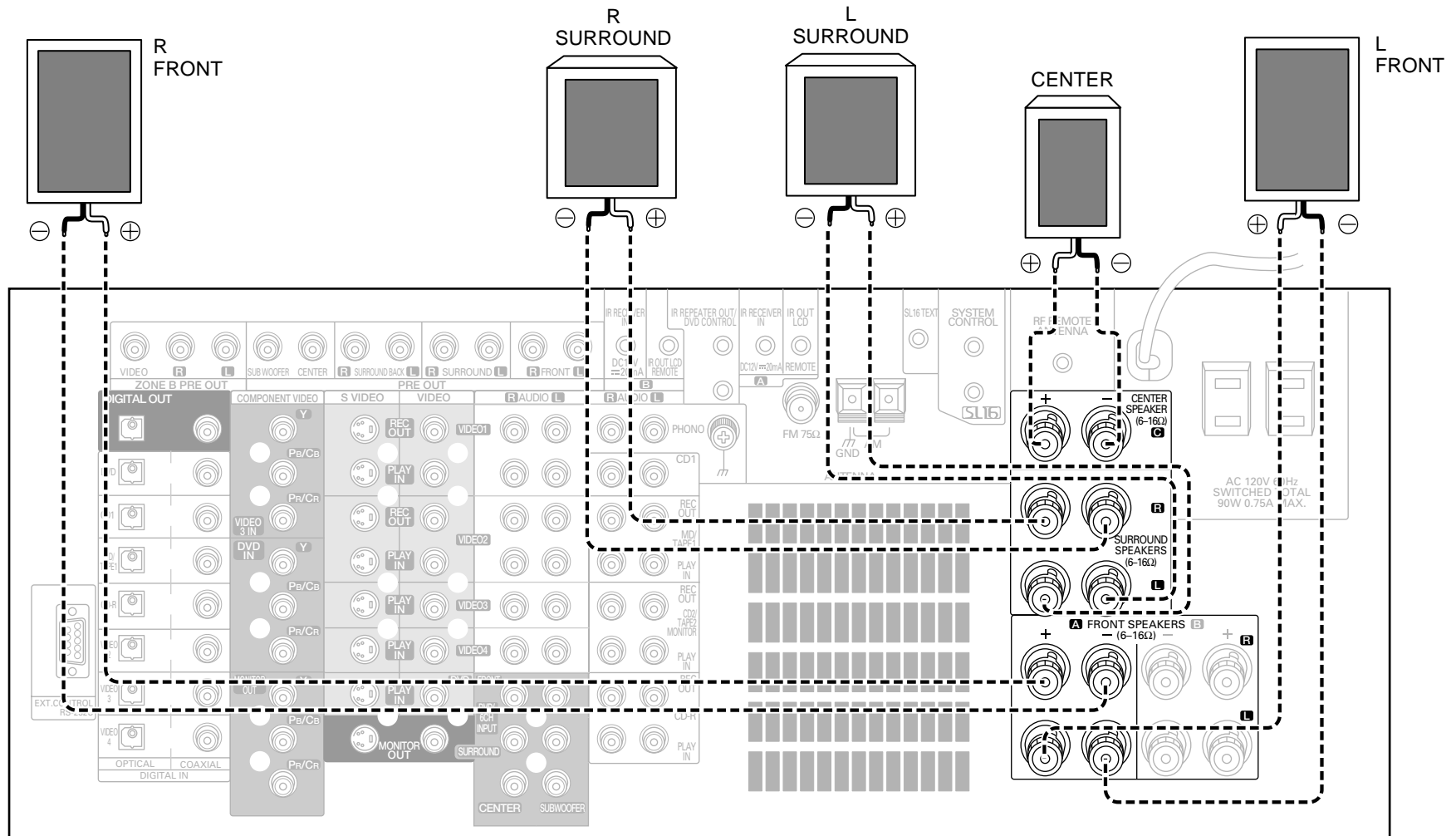

## Connecting Your Speakers, continued

**Do not** plug in the receiver to AC power until all connections have been made.

### To Connect Front Speakers Only:

If you only intend to listen to stereo sound (as opposed to surround sound), you may simply connect a single pair of speakers. To do so:

#### Using Banana Plugs:

1. Tighten the speaker wire binding posts. If you do not tighten the posts, they will not conduct sound properly to the speakers.
2. Insert the plug from the positive jack on the **RIGHT FRONT** speaker into the pin jack on the positive **RIGHT FRONT** post. Repeat for the negative plug.
3. Repeat step 2 for the positive and negative wires on the **LEFT FRONT** speaker.

#### Using Bare Wires:

1. Loosen the speaker wire binding posts.
2. Insert the wire from the positive jack on the **RIGHT FRONT** speaker into the U-shaped slot in the base of the positive **RIGHT FRONT** post. Lay the wire to the right of the post; that way, when you tighten the binding post, it will naturally twist the wire into the best connection. Tighten the post. Repeat for the negative wire on the **RIGHT FRONT** speaker as shown to the right.
3. Repeat step 2 for the positive and negative wires on the **LEFT FRONT** speaker.

### To Connect Front and Surround Sound Speakers:

To listen to the full surround sound that this receiver can put out, connect front speakers, center, left surround, and right surround speakers. To do so:

For the connections of the subwoofer and surround back speakers, see page 6 - 7.

#### Using Banana Plugs:

1. Tighten the speaker wire binding posts. If you do not tighten the posts, they will not conduct sound properly to the speakers.
2. Follow the steps under "To Connect Front Speakers Only" on this page to connect the **RIGHT** and **LEFT FRONT** speakers.
3. Insert the plug from the positive jack on the **CENTER** speaker into the pin jack on the positive **CENTER** post. Repeat for the negative plug.
4. Insert the plug from the positive jack on the **RIGHT SURROUND** speaker into the pin jack on the positive **RIGHT SURROUND** post. Repeat for the negative plug.
5. Repeat step 4 for the positive and negative wires on the **LEFT SURROUND** speaker.

#### Using Bare Wires:

1. Loosen the speaker wire binding posts.
2. Follow the steps under "To Connect Front Speakers Only" on this page to connect the **RIGHT** and **LEFT FRONT** speakers.
3. Insert the wire from the positive jack on the **CENTER** speaker into the U-shaped slot in the base of the positive **CENTER** post, as shown to the right. Tighten the post. Repeat for the negative wire.

4. Insert the wire from the positive jack on the **RIGHT SURROUND** speaker into the U-shaped slot on the base of the positive **RIGHT SURROUND** post. Tighten the post. Repeat for the negative wire.
5. Repeat step 4 for the positive and negative wires on the **LEFT SURROUND** speaker.



Never short circuit the + and - speaker wires.

Do not switch the left and right speaker wires or swap the + and - wires on the binding posts.

The speakers must have a nominal impedance of between 6Ω and 16Ω.

#### Using Bare Wires



1. Loosen post



2. Insert wire



3. Tighten post

### Connecting Your Speakers, continued

6

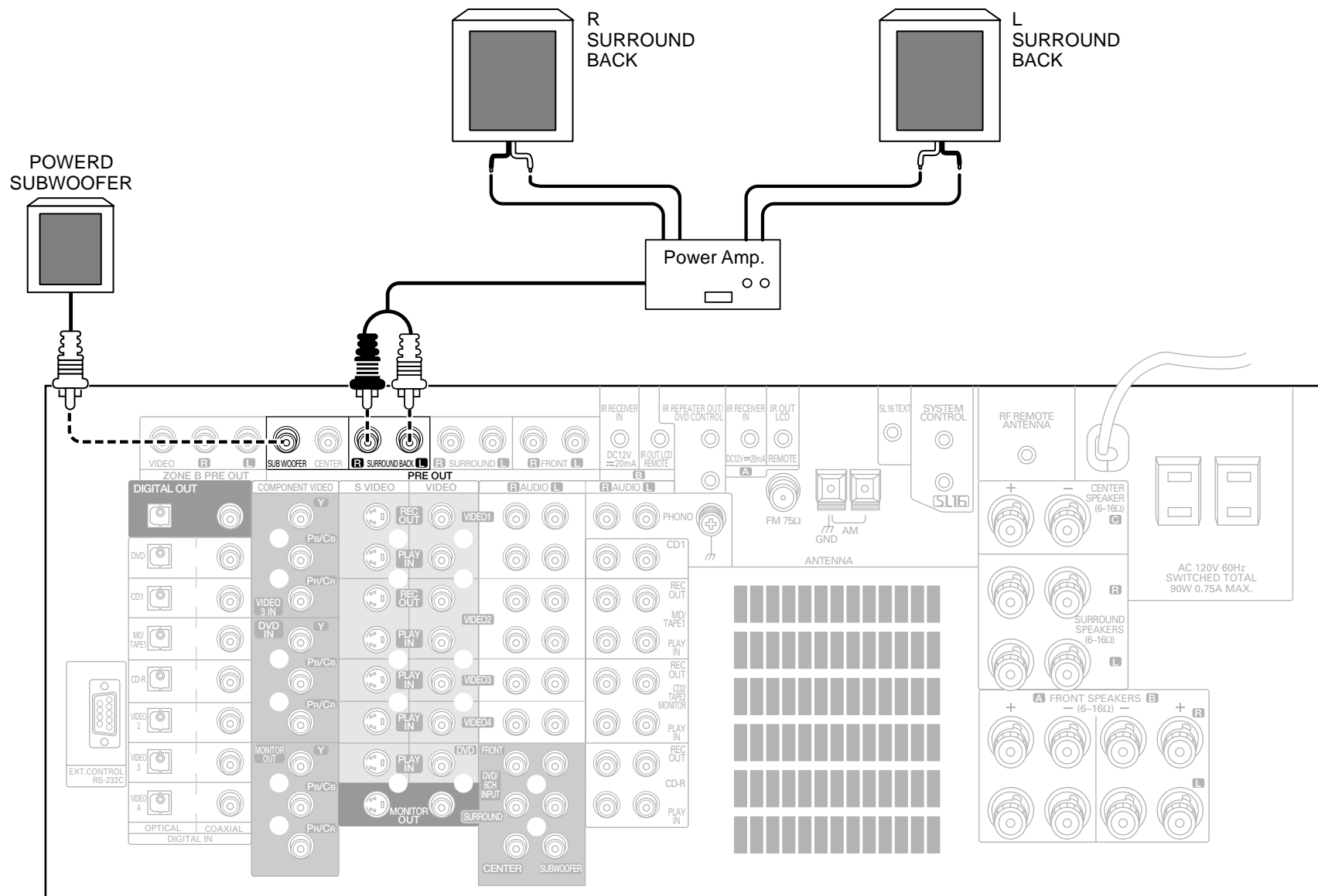

The figure shows an example for the VR-5700.

## Connecting Your Speakers, continued

**Do not** plug in the amplifiers or the receiver to AC power until all connections have been made.

### **What if I Have a Powered Subwoofer?**

Simply connect the subwoofer's audio cable to the receiver's **SUBWOOFER PRE OUT** jack as shown to the left.

### **To Connect Surround Back Speakers:**

To reproduce the surround back channels of THX Surround EX, DTS-ES or DTS-NEO:6, you need to use a 2-channel power amplifier to power the surround back speakers.

To connect the surround back speakers:

1. Using RCA audio cables (not supplied), connect the receiver's **SURROUND BACK PRE OUT** jacks to the 2-channel power amplifiers' input jacks as shown to the left.
2. Connect the speakers to the power amplifier according to the amplifiers' instruction manuals.

### What if I Have an Amplifier?

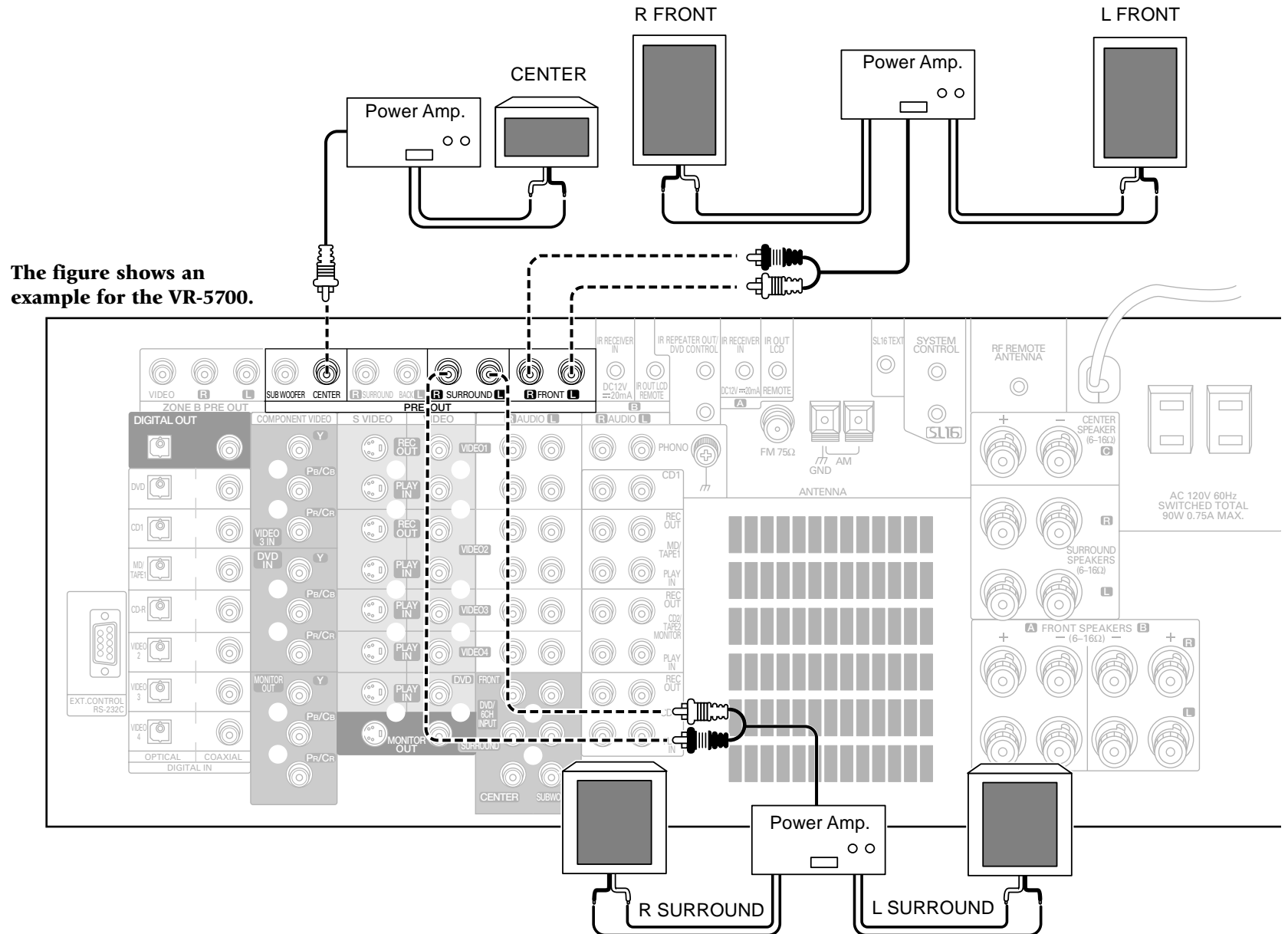

## What if I Have an Amplifier?, continued

You can use supplemental power amplifiers for any of the channels instead of the receiver's built-in amplifiers.

**Do not** plug in the amplifiers or the receiver to AC power until all connections have been made.

To connect supplemental power amplifiers:

1. Using RCA audio cables (not supplied), connect the receiver's **PRE OUT** jacks to the amplifiers' input jacks as shown to the left.
2. Connect the speakers to the power amplifiers according to the amplifiers' instruction manuals.







## NOTES

**Do not** plug in the receiver or devices to AC power until you have connected all your devices.

This section focuses on the connections from your TV to the VR-5700/VR-5090/VR-5080. Please refer to your TV's instructions for more detail about its connection jacks and capabilities.

The instructions in this section show how to connect your TV as a monitor for the other video devices you connect (without using it as an audio/video source device itself). To use your TV as an audio/video source device, you must first connect it as described in this section, and also connect its audio/video output jacks as if they were cable TV tuner outputs, as described in "To Connect a Cable TV Tuner with a Composite (RCA) Video Output" on page 13.

## Connecting Your TV, continued

### To Connect a TV:

1. Review the information under "Before You Begin" on page 1. It contains important notes about the types of video connections you can make.
2. Connect a video cable from your TV's Video IN jack to the receiver's **MONITOR OUT** jack as shown to the left.
3. If your TV does not have any video input connections, you must purchase an RF modulator. The modulator will convert the video signal from the receiver to an RF signal that will work with the TV's antenna connections. Connect the receiver to the TV according to the RF modulator's instruction manual.
4. Go to "Noting Your Devices" on page 3 and note which jack you used to connect your TV. In addition, note the brand name and model number of the TV.

If you previously connected your TV directly to your VCR, you must now connect it through your new receiver.

### What if I Want to Watch TV without Turning on the Receiver?

The connection described here sets your TV up as a monitor you can use to view media played on your other video devices (such as a VCR or DVD player). You can still watch TV without having to use the receiver.



## NOTES

With some devices, the **COMPONENT VIDEO** jacks (Y, PB/CB, PR/CR jacks) are indicated as the R-Y, B-Y jacks. For details, refer to the operation instructions for the respective device.

### Connecting Your Cable TV or Satellite Tuner

12

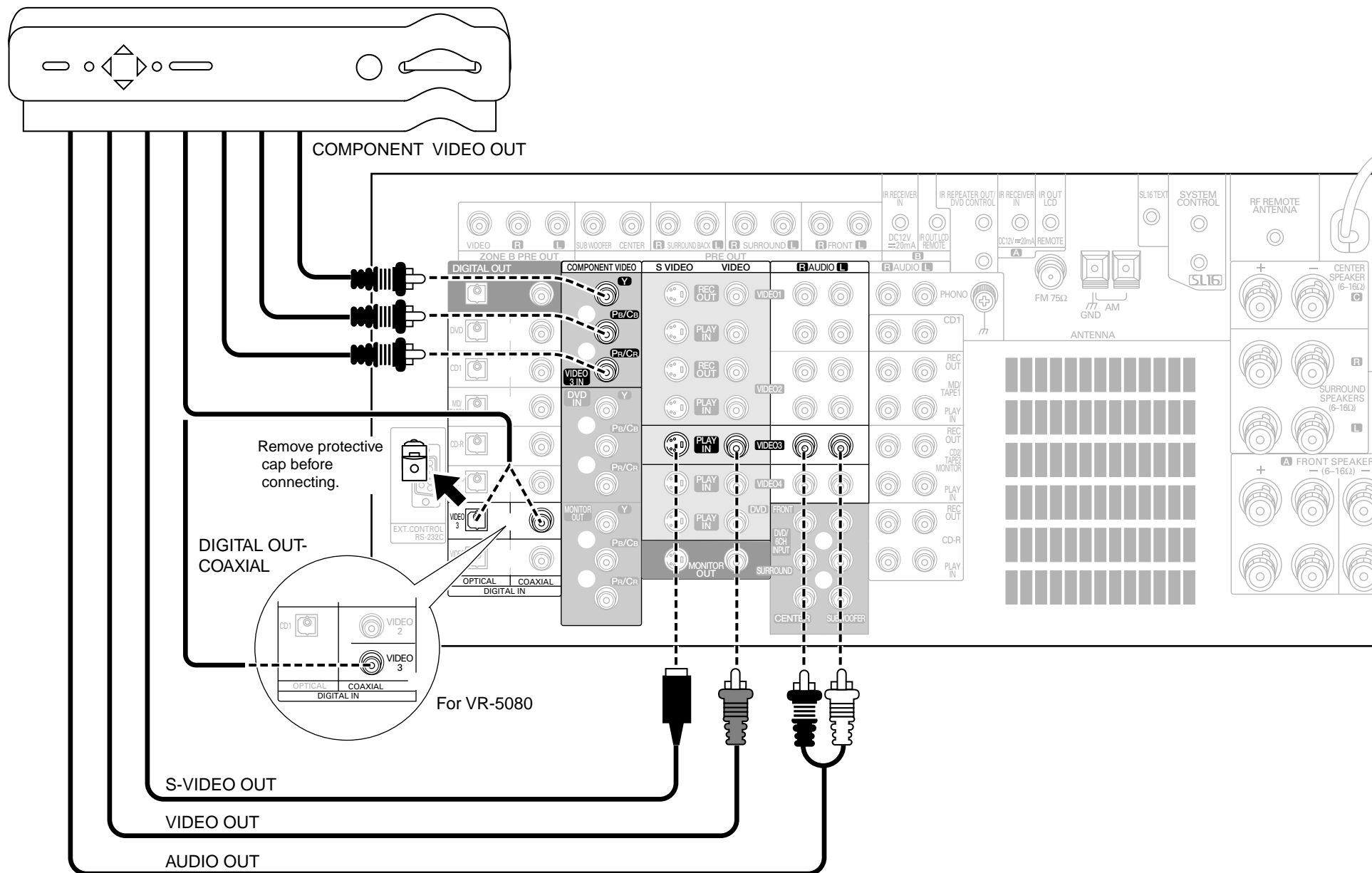

## Connecting Your Cable TV or Satellite Tuner, continued

### NOTES

**Do not** plug in the receiver or devices to AC power until you have connected all your devices.

This section focuses on the connections from your cable or satellite tuner to the VR-5700/VR-5090/VR-5080. Please refer to your tuner's instructions for more detail about its connection jacks and capabilities.

The instructions in this section show one of several possible variations on connecting your tuner. For further assistance on optional configurations, contact your cable or satellite provider.

The VR-5080 is not equipped with VIDEO4 jacks.

#### To Connect a Cable TV Tuner with a Composite (RCA) Video Output:

1. Review the information under "Before You Begin" on page 1. It contains important notes about the types of video connections you can make.
2. Connect the audio and video cables from the cable tuner's Audio and Video OUT jacks to the receiver's **VIDEO2**, **VIDEO3**, or **VIDEO4 PLAY IN** jacks as shown to the left.

When component video cables are connected, the audio and video cables of the cable TV tuner should be connected to the **VIDEO3** jacks of the receiver.

3. Go to "Noting Your Devices" on page 3 and note which jack you used to connect your tuner. In addition, note the brand name and model number of the tuner.

#### To Connect a Cable TV Tuner without a Composite (RCA) Video Output:

1. Connect the audio cables from the cable tuner's Audio Out jacks to the receiver's **VIDEO2**, **VIDEO3**, or **VIDEO4 PLAY IN** jacks as shown to the left.
2. Leave the cable tuner's video out (RF jack) connected directly to your VCR or TV (wherever you already have it connected).
3. Go to "Noting Your Devices" on page 3 and note which jack you used to connect your tuner. In addition, note the brand name and model number of the tuner.

#### To Connect a Satellite Tuner:

1. Review the information under "Before You Begin" on page 1. It contains important notes about the types of video connections you can make.
2. If your satellite tuner has a digital output jack, connect a digital (optical or coaxial) cable between the satellite tuner's digital output jack and the receiver's **VIDEO2**, **VIDEO3** or **VIDEO4** digital input jack as shown in the figure on the left. (The optical digital input jacks are available only on the VR-5700/VR-5090)

The illustration shows two digital connections, one for coaxial connection and one for optical connection. Your Satellite tuner supports one or the other of these connection methods—**do not** connect both.

3. Connect the audio and video cables from the satellite tuner's Audio and Video OUT jacks to the receiver's **VIDEO2**, **VIDEO3**, or **VIDEO4 PLAY IN** jacks as shown to the left.

Note that the jack sets are linked, even though they are not adjacent. You **must** connect all of the cables from your satellite receiver to a linked jack set. For example, if you connect the analog cables to **VIDEO2** and the digital optical cable to **VIDEO3**, your receiver will not work correctly.

When component video cables are connected, the audio and video cables of the cable TV tuner should be connected to the **VIDEO3** jacks of the receiver.

4. Go to "Noting Your Devices" on page 3 and note which jack you used to connect your tuner. In addition, note the brand name and model number of the tuner.

### NOTES

To play Dolby Digital or DTS-encoded software in multi-channel configuration, you must connect the source device via a digital connection.

### Connecting Your VCR(s)

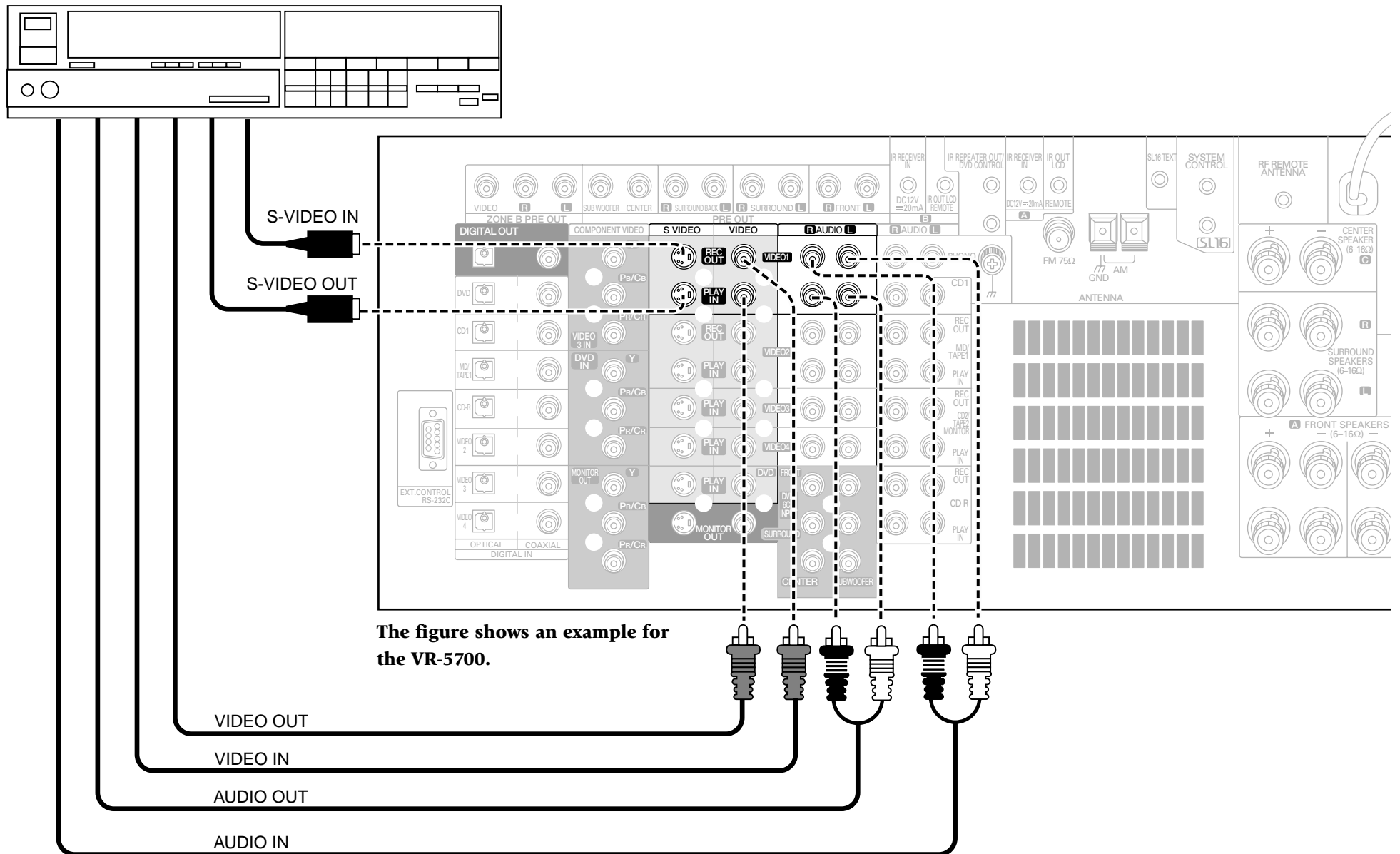



## NOTES

**Do not** plug in the receiver to AC power until you have connected all your devices.

This section focuses on the connections from your VCR to the VR-5700/VR-5090/VR-5080. Please refer to your VCR's instructions for more detail about its connection jacks and capabilities.

The instructions in this section show one of several possible variations on connecting your VCR. For further assistance on optional configurations, contact the store where you purchased your receiver.

## Connecting Your VCR(s), continued

### To Connect a Primary VCR:

1. Review the information under "Before You Begin" on page 1. It contains important notes about the types of video connections you can make.
2. Connect the audio and video cables from the VCR's Audio and Video jacks to the receiver's **VIDEO1 REC OUT** and **PLAY IN** jacks as shown to the left.
3. Be sure to connect the VCR VIDEO IN cable to the jack labeled REC OUT and the VIDEO OUT cable to the jack labeled PLAY IN.
4. Go to "Noting Your Devices" on page 3 and note which jack you used to connect your VCR. In addition, note the brand name and model number of the VCR.

### To Connect a Secondary VCR:

1. Review the information under "Before You Begin" on page 1. It contains important notes about the types of video connections you can make.
2. Connect the audio and video cables from the VCR's Audio and Video jacks to the receiver's **VIDEO2** jacks.
3. Go to "Noting Your Devices" on page 3 and note which jack you used to connect your VCR. In addition, note the brand name and model number of the VCR.

### Connecting Your Primary CD Player

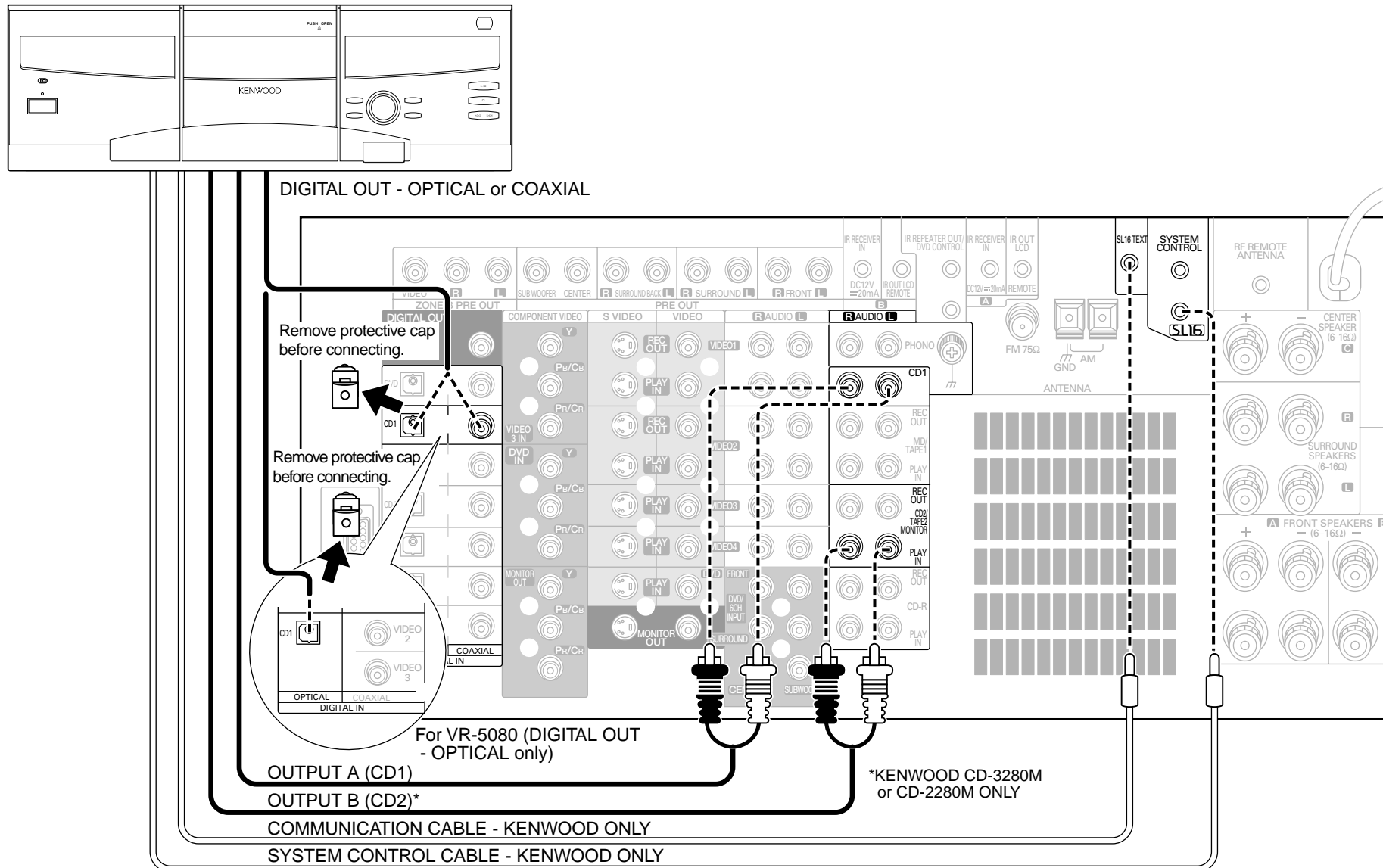

## Connecting Your Primary CD Player, continued

### NOTES

**Do not** plug in the receiver to AC power until you have connected all your devices.

This section focuses on the connections from your 200-Disc CD Changer to the VR-5700/VR-5090/VR-5080. Please refer to your changer's instructions for more detail about its connection jacks and capabilities.

Each set of instructions in this section shows one of several possible variations on connecting your CD player(s). For further assistance on optional configurations, contact the store where you purchased your CD player(s).

The illustration shows a Kenwood 200-Disc CD Changer. Your CD player may look different.

The Kenwood CD-3280M and CD-2280M 200-Disc Changers contain two CD transports. You must connect these devices as though they were two CD players.

### What if I Have a Video CD-Compatible CD Player?

Connect the audio and video cables from the CD player to any unused Video jack set.

**Do not** connect the system control cable in this instance.

### To Connect a Kenwood 200-Disc CD Changer:

1. Connect one set of audio cables from the 200-Disc Changer to the receiver's CD1 jacks. If you have a CD-3280M or CD-2280M, connect Output A to the receiver's **CD1** jacks and Output B to the receiver's **CD2/TAPE2 MONITOR PLAY IN** jacks as shown to the left.
2. Connect the digital cable from the changer to the receiver's **CD1** digital jack as shown to the left.
3. Connect the system control cable from the changer to the **SYSTEM CONTROL** jack as shown to the left.

The illustration shows two digital connections, one for coaxial connection and one for optical connection. Your CD player supports one or the other of these connection methods—**do not** connect both. (The coaxial digital input jacks are available only on the VR-5700/VR-5090.)

Be sure that the SL16/XS8 switch on the changer is set to SL16.

If you are connecting more than one Kenwood device with a system control cable, see "What if I Have Several Kenwood Devices (System Control Chaining)?" on page 32 for more information.

4. Connect the SL16 text cable (communication cable) from the changer to the receiver's SL16 TEXT jack as shown to the left.
5. Go to "Noting Your Devices" on page 3 and note which jacks you used to connect your CD changer. In addition, note the brand name and model number of the CD Changer.

### To Connect Any Other Primary CD Player or Changer:

1. Connect the audio cables from the CD player's audio jacks to the receiver's **CD1** jack set as shown to the left.
2. Connect the digital cable from the CD player's digital jack to the receiver's **CD1** digital jack as shown to the left.

The illustration shows two digital connections, one for coaxial connection and one for optical connection. Your CD player supports one or the other of these connection methods—**do not** connect both. (The coaxial digital input jacks are available only on the VR-5700/VR-5090.)

3. If you are connecting a Kenwood CD Player with system control, connect the system control cable from the CD player to the system control jack as shown to the left.

Be sure that the SL16/XS8 switch on the player/changer is set to SL16.

If you are connecting more than one Kenwood device with a system control cable, see "What if I Have Several Kenwood Devices (System Control Chaining)?" on page 32 for more information.

4. Go to "Noting Your Devices" on page 3 and note which jacks you used to connect your CD player/changer. In addition, note the brand name and model number of the CD player or changer.

### To Connect a Secondary CD Player:

See "Connecting Your Secondary CD Player or Tape Deck" on page 24.

**Do not** connect the system control cable in this instance.

### NOTES

To play an HDCD disc in the HDCD format or a DTS-encoded disc in multi-channel configuration, you must connect the source device via a digital connection.

### Connecting Your DVD Player

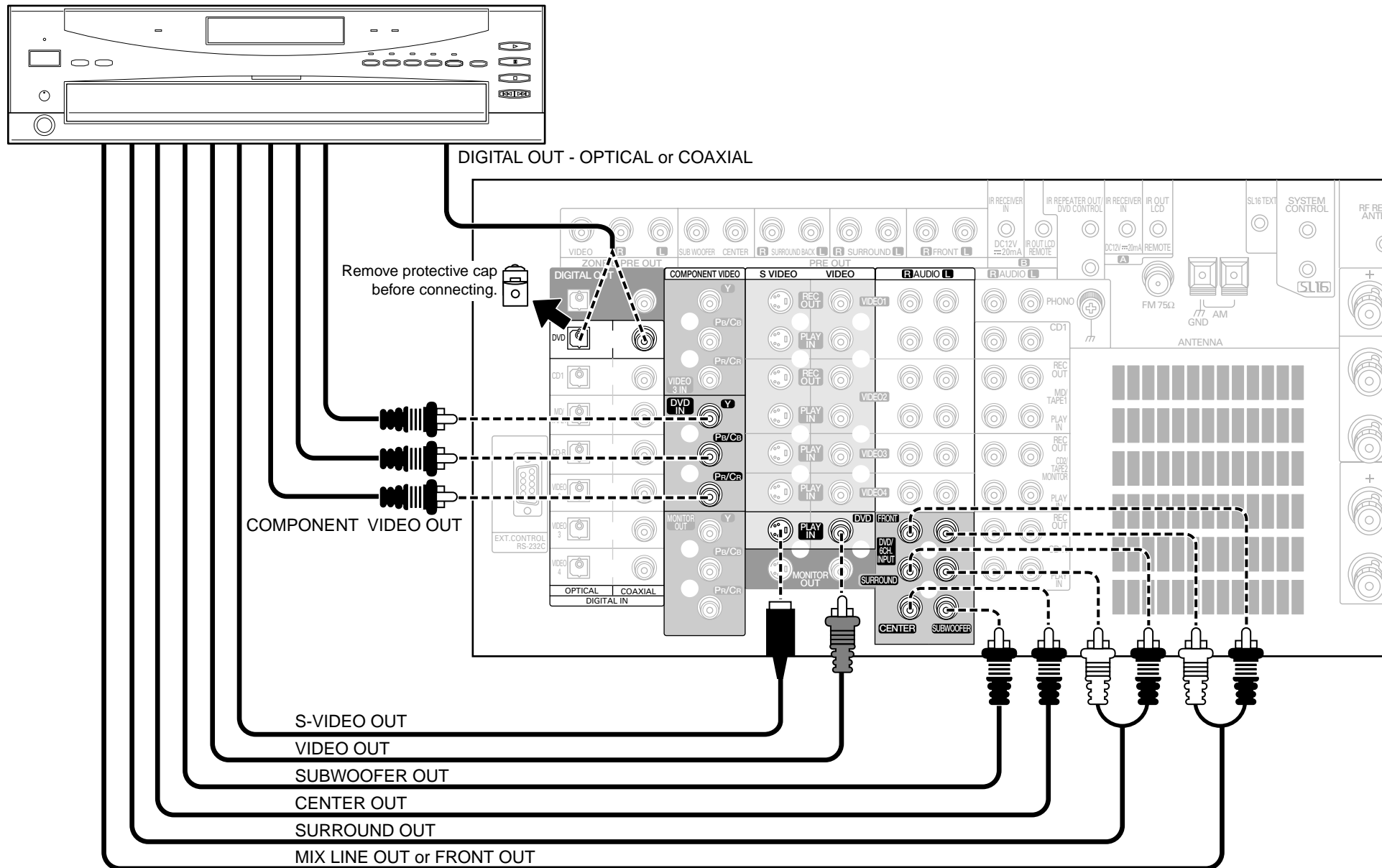



## Connecting Your DVD Player, continued

### NOTES

**Do not** plug in the receiver to AC power until you have connected all your devices.

This section focuses on the connections from your DVD player to the VR-5700/VR-5090/VR-5080. Please refer to your DVD player's instructions for more detail about its connection jacks and capabilities.

The instructions in this section show one of several possible variations on connecting your DVD player. For further assistance on optional configurations, contact the store where you purchased your receiver.

#### To Connect a DVD Player:

1. Review the information under "Before You Begin" on page 1. It contains important notes about the types of video connections you can make.
2. Connect the video cables from the DVD's Video jacks to the receiver's **DVD PLAY IN** jacks as shown to the left. If your DVD and TV have the COMPONENT VIDEO jacks, you can also connect them as shown on the left.
3. Connect the audio cables from the DVD's audio jacks (AUDIO OUT, FRONT or MIX LINE OUT) to the receiver's **FRONT** jacks of **DVD/6CH. INPUT**.

When the DVD player provides the DVD 6ch (DVD 5.1 ch) outputs, connect them to the **FRONT, SURROUND, CENTER** and **SUBWOOFER** input jacks. (optional)

4. Connect the digital cable (either optical or coaxial) from the DVD's digital jack to the appropriate digital jack on the receiver as shown to the left.

The illustration shows two digital connections, one for coaxial connection and one for optical connection. Your DVD player supports one or the other of these connection methods—**do not** connect both.

5. Go to "Noting Your Devices" on page 3 and note which jacks you used to connect your DVD player. In addition, note the brand name and model number of the DVD player.

### NOTES

To play Dolby Digital or DTS-encoded software in multi-channel configuration, you must connect the source device via a digital connection.

The digital inputs of the receiver are not compatible with a stereo signal with 192 kHz sampling frequency or a multi-channel signal with 96 kHz sampling frequency. These signals should be input to the analog **DVD/6CH.** input jacks.

#### DTS disclaimer clause

DTS Digital Surround™ is a discrete 5.1 channel digital audio format available on CD, LD, and DVD software which consequently cannot be decoded and played back inside most CD, LD, or DVD players. For this reason, when DTS-encoded software is played back through the analog outputs of the CD, LD, or DVD player, excessive noise will be exhibited. To avoid possible damage to the audio system, proper precautions should be taken by the consumer if the analog outputs are connected directly to an amplification system. To enjoy DTS Digital Surround™ playback, an external 5.1 channel DTS Digital Surround™ decoder system must be connected to the digital output (S/PDIF, AES/EBU, or TosLink) of the CD, LD or DVD player.

This unit is equipped with DTS Digital Surround™ decoder.

# Connecting Your CD-R Recorder

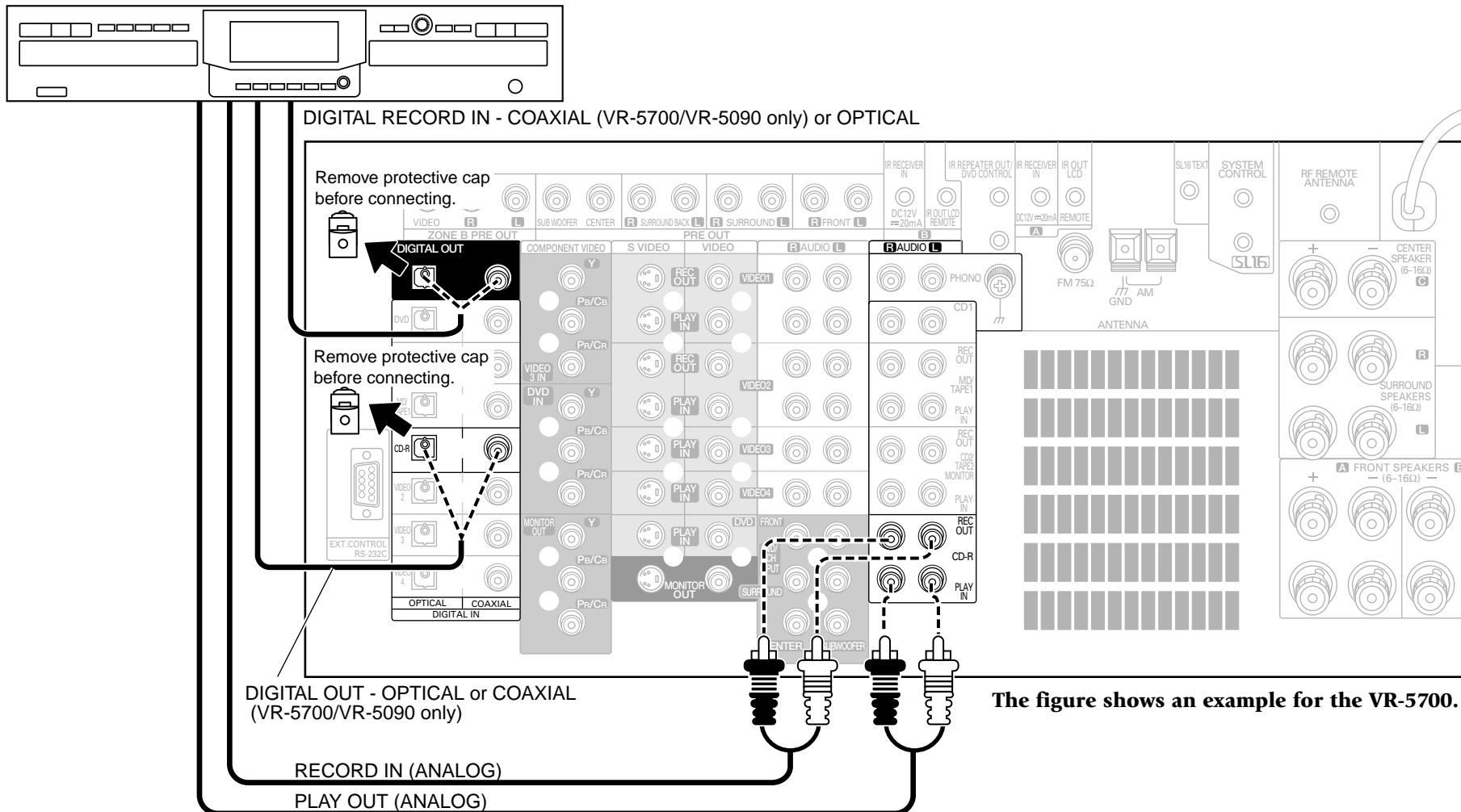

## Connecting Your CD-R Recorder, continued



**Do not** plug in the receiver to AC power until you have connected all your devices.

This section focuses on the connections from your CD-R recorder to the VR-5700/VR-5090/VR-5080. Please refer to your CD-R recorder instructions for more detail about its connection jacks and capabilities.

Each set of instructions in this section shows one of several possible variations on connecting your CD-R recorder. For further assistance on optional configurations, contact the store where you purchased your CD-R recorder.

The VR-5080 is not equipped with the digital input jack for CD-R recorder.

### To Connect a CD-R Recorder:

1. Connect the audio cable from the CD-R recorder's Play OUT jacks to the receiver's **CD-R PLAY IN** jacks as shown to the left.
2. Connect the audio cable from the CD-R recorder's Rec IN jacks to the receiver's **CD-R REC OUT** jacks, as shown to the left.
3. Connect the digital cable (either optical or coaxial) from the CD-R's digital jack to the appropriate digital jack on the receiver as shown to the left. (The coaxial digital output jack is available only on the VR-5700/VR-5090.)  
The illustration shows two digital connections, one for coaxial connection and one for optical connection. Your CD-R recorder supports one or the other of these connection methods—**do not** connect both.  
You only need to connect to the digital output jack if you will be recording from sources that are connected to a digital input jack, such as a CD or DVD player.
4. Go to "Noting Your Devices" on page 3 and note which jacks you used to connect your CD-R recorder. In addition, note the brand name and model number of the CD-R recorder.

### Connecting Your MD Recorder or Primary Tape Deck

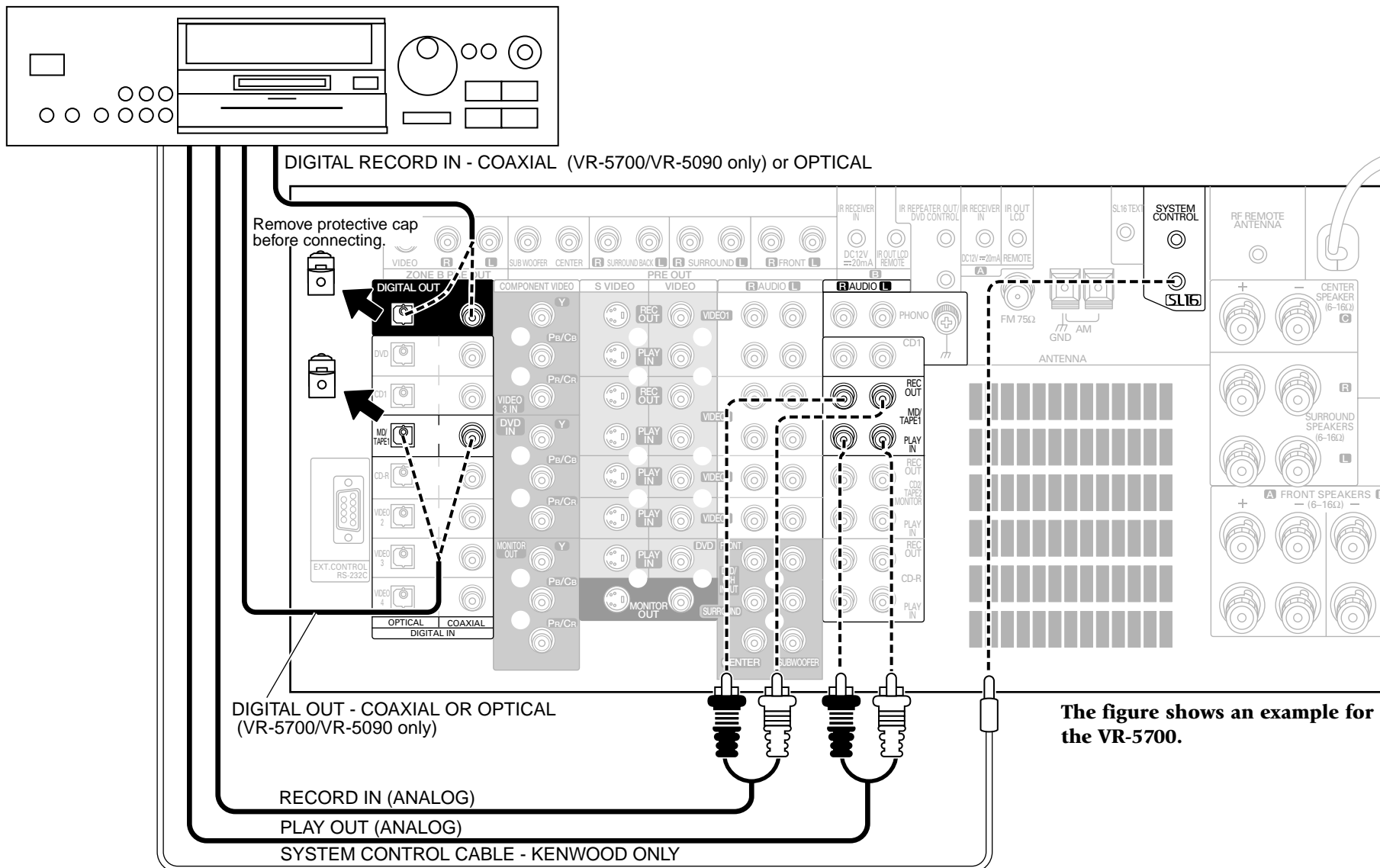

## Connecting Your MD Recorder or Primary Tape Deck, continued



**Do not** plug in the receiver to AC power until you have connected all your devices.

This section focuses on the connections from your MD recorder or tape deck to the VR-5700/VR-5090/VR-5080. Please refer to your MD recorder or tape deck's instructions for more detail about its connection jacks and capabilities.

Each set of instructions in this section shows one of several possible variations on connecting your MD recorder or tape deck. For further assistance on optional configurations, contact the store where you purchased your MD recorder or tape deck.

The VR-5080 is not equipped with the digital input jack for MD recorder.

### To Connect an MD Recorder:

1. Connect the audio cable from the MD recorder's Play OUT jacks to the receiver's **MD/TAPE1 PLAY IN** jacks as shown to the left.
2. Connect the audio cable from the MD recorder's Rec IN jacks to the receiver's **MD/TAPE1 REC OUT** jacks, as shown to the left.
3. Connect the digital cable (either optical or coaxial) from the MD's digital jack to the appropriate digital jack on the receiver as shown to the left. (The coaxial digital output jacks are available only on the VR-5700/VR-5090)

The illustration shows two digital connections, one for coaxial connection and one for optical connection. Your MD recorder supports one or the other of these connection methods—**do not** connect both.

You only need to connect to the digital output jack if you will be recording from sources that are connected to a digital input jack, such as a CD or DVD player.

4. If you are connecting a Kenwood MD recorder, connect the system control cable from the MD recorder to the receiver.

If you are connecting more than one Kenwood device with a system control cable, see "What if I Have Several Kenwood Devices (System Control Chaining)?" on page 32.

5. Go to "Noting Your Devices" on page 3 and note which jacks you used to connect your MD recorder. In addition, note the brand name and model number of the MD recorder.

### To Connect a Primary Tape Deck:

1. Connect the audio cable from the tape deck's Play OUT jacks to the receiver's **MD/TAPE1 PLAY IN** jacks as shown to the left.
2. Connect the audio cable from the tape deck's Rec IN jacks to the receiver's **MD/TAPE1 REC OUT** jacks as shown to the left.
3. If you are connecting a Kenwood tape deck with system control, connect the system control cable from the tape deck to the receiver. Be sure that the SL16/XS8 switch on the tape deck is set to SL16.

If you are connecting more than one Kenwood device with a system control cable, see "What if I Have Several Kenwood Devices (System Control Chaining)?" on page 32.

4. Go to "Noting Your Devices" on page 3 and note which jacks you used to connect your tape deck. In addition, note the brand name and model number of the tape deck.

### To Connect a Secondary Tape Deck:

See "Connecting Your Secondary CD Player or Tape Deck" on page 24.

### Connecting Your Secondary CD Player or Tape Deck

24

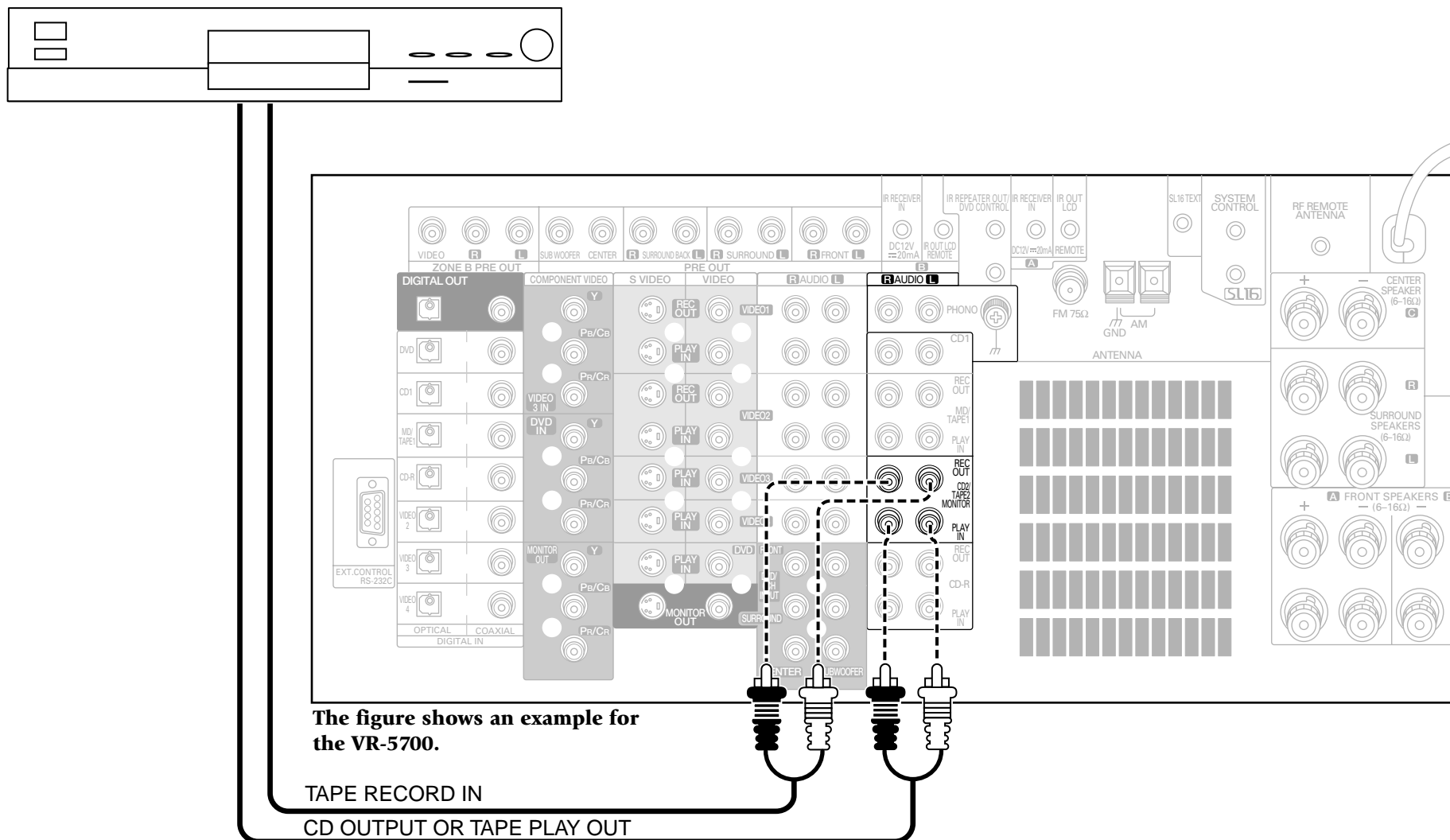

The figure shows an example for the VR-5700.

TAPE RECORD IN  
CD OUTPUT OR TAPE PLAY OUT

## Connecting Your Secondary CD Player or Tape Deck, continued



**Do not** plug in the receiver to AC power until you have connected all your devices.

This section focuses on the connections from your CD player or tape deck to the VR-5700/VR-5090/VR-5080. Please refer to your CD player or tape deck's instructions for more detail about its connection jacks and capabilities.

Each set of instructions in this section shows one of several possible variations on connecting your CD player or tape deck. For further assistance on optional configurations, contact the store where you purchased your CD player or tape deck.

**Do not** connect a system control cable from any unit connected via the **CD2/TAPE2 MONITOR** jacks.

### To Connect a Secondary CD Player:

1. Connect the audio cables from the CD player's audio jacks to the receiver's **CD2/TAPE2 MONITOR PLAY IN** jack set as shown to the left.

**Do not** connect the system control cable from the second CD player, even if it supports system control.

2. Go to "Noting Your Devices" on page 3 and note which jacks you used to connect your CD player. In addition, note the brand name and model number of the CD player.

If you connect a second tape deck, you cannot connect a second CD player.

### To Connect a Secondary Tape Deck:

1. Connect the audio cable from the tape deck's Play OUT jacks to the receiver's **CD2/TAPE2 MONITOR PLAY IN** jacks.

2. Connect the audio cable from the tape deck's Rec IN jacks to the receiver's **CD2/TAPE2 MONITOR REC OUT** jacks.

**Do not** connect the system control cable from the second tape deck, even if it supports system control.

3. Go to "Noting Your Devices" on page 3 and note which jacks you used to connect your tape deck. In addition, note the brand name and model number of the tape deck.

If you connect a second CD player, you cannot connect a second tape deck.





## Connecting Your Laser Disc Player (with AC-3 RF Output), continued

### NOTES

**Do not** plug in the receiver to AC power until you have connected all your devices.

You must purchase an RF Demodulator (such as the Kenwood DEM-9991D available from one of our parts distributors) if you plan to operate a player with a Dolby Digital (AC-3) RF output with this receiver.

These instructions describe how to connect a laser disc player with an AC-3 RF Output. If your laser disc player does not have an AC-3 RF output, see "Connecting Your Laser Disc Player (without AC-3 RF Output)" on page 28. Please refer to your laser disc player's instructions for more detail about its connection jacks and capabilities.

The instructions in this section show one of several possible variations on connecting your laser disc player. For further assistance on optional configurations, contact the store where you purchased your receiver.

### To Connect an AC-3 RF Output Laser Disc Player:

1. Review the information under "Before You Begin" on page 1. It contains important notes about the types of video connections you can make.
2. Connect the audio cables from the laser disc player's Audio OUT jacks to the receiver's **AUDIO** jacks (**VIDEO 3 PLAY IN**) as shown to the left.  
**Do not** connect the digital cable (optical or coaxial) yet; it must be connected via the demodulator as described in the following steps.
3. Connect the AC-3 RF coaxial cable from the laser disc player's AC-3 RF OUT jack to the demodulator's **RF INPUT AC-3 RF** jack as shown to the left.
4. Connect the digital cable (either optical or coaxial) from the laser disc player's digital jack to the appropriate **DIGITAL INPUT** jack on the demodulator as shown to the left.

5. Connect the digital cable from the demodulator's **DIGITAL OUTPUT** jack to one of the receiver's **VIDEO3** digital input jacks.
6. Go to "Noting Your Devices" on page 3 and note which jacks you used to connect your laser disc player. In addition, note the brand name and model number of the laser disc player.

### NOTES

To play Dolby Digital\* or DTS-encoded software in multi-channel configuration, you must connect the source device via a digital connection.

\*When playing a LaserDisc recorded in the Dolby Digital format, connect the AC-3 RF output to the receiver.

### Connecting Your Laser Disc Player (without AC-3 RF Output)

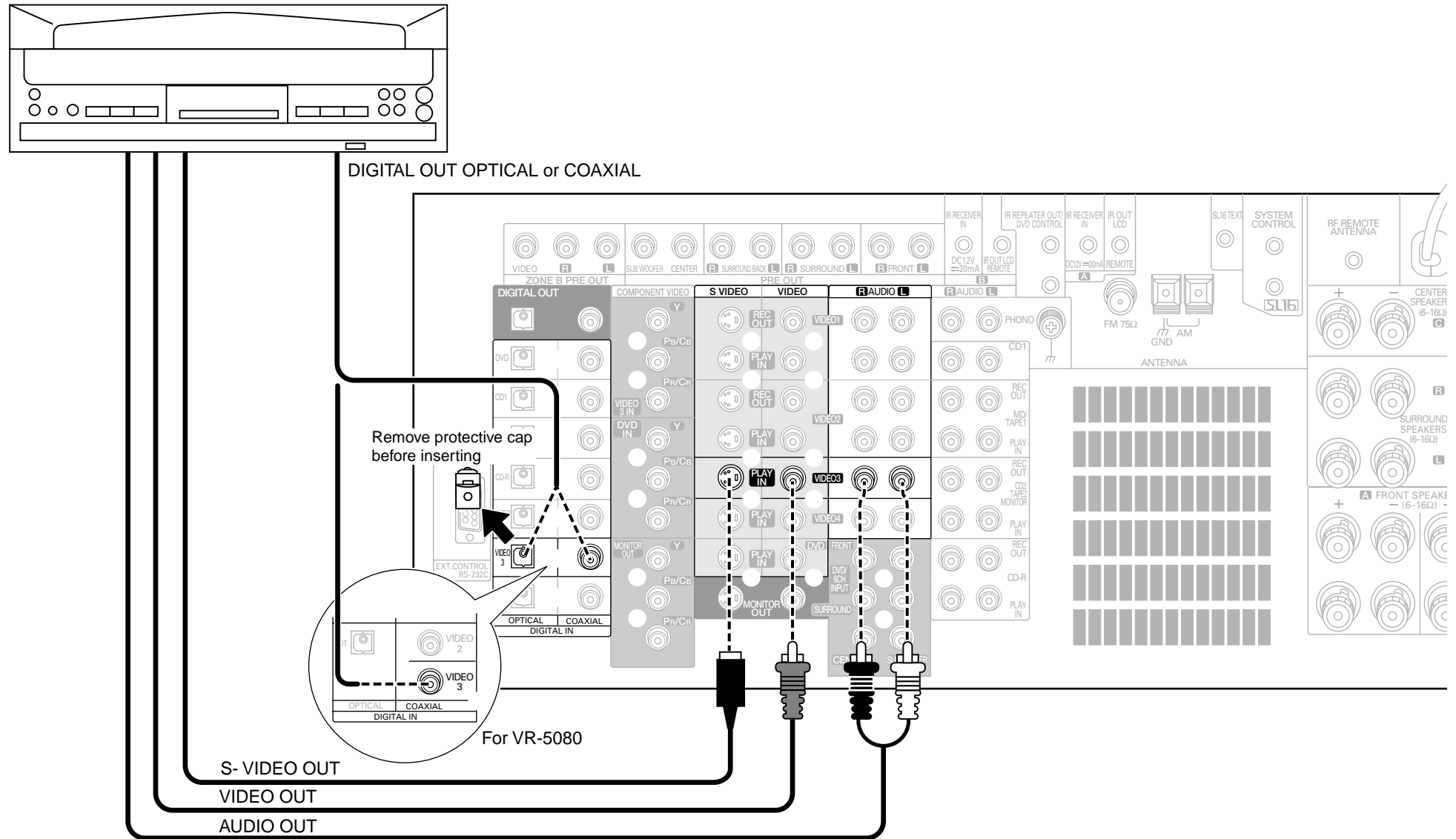

## Connecting Your Laser Disc Player (without AC-3 RF Output), continued

### NOTES

**Do not** plug in the receiver to AC power until you have connected all your devices.

These instructions describe how to connect a laser disc player with a PCM Digital Output. If your player has a Dolby Digital (AC-3) RF Out, see “Connecting Your Laser Disc Player (with AC-3 RF Output)” on page 26. This configuration does not allow Dolby Digital laser discs to be played. Please refer to your laser disc player’s instructions for more detail about its connection jacks and capabilities.

The instructions in this section show one of several possible variations on connecting your laser disc player. For further assistance on optional configurations, contact the store where you purchased your receiver.

### To Connect a PCM Digital Output Laser Disc Player:

1. Review the information under “Before You Begin” on page 1. It contains important notes about the types of video connections you can make.
2. Connect the audio cables from the laser disc player’s Audio OUT jacks to the receiver’s **AUDIO** jacks (**VIDEO3 PLAY IN**) as shown to the left.
3. Connect the video cable from the laser disc player’s Video OUT jack to the receiver’s **VIDEO PLAY IN** jack as shown to the left.

Note that the jack sets are linked, even though they are not adjacent. You **must** connect all of the cables from your laser disc player to a linked jack set. If you connect the analog cables to **VIDEO2** and the digital cable to **VIDEO3**, your receiver will not work correctly.

4. Connect the digital cable (either optical or coaxial) from the laser disc player’s digital jack to the appropriate digital jack on the receiver as shown to the left. Your laser disc player supports only one of the digital connection methods—**do not** connect both. (The optical digital input jacks are available only on the VR-5700/VR-5090)
5. Go to “Noting Your Devices” on page 3 and note which jacks you used to connect your laser disc player. In addition, note the brand name and model number of the laser disc player.

### NOTES

When play DTS-encoded software in multichannel configuration, the connected audio signal should be the digital signal.

## Connecting Your Turntable/Record Player

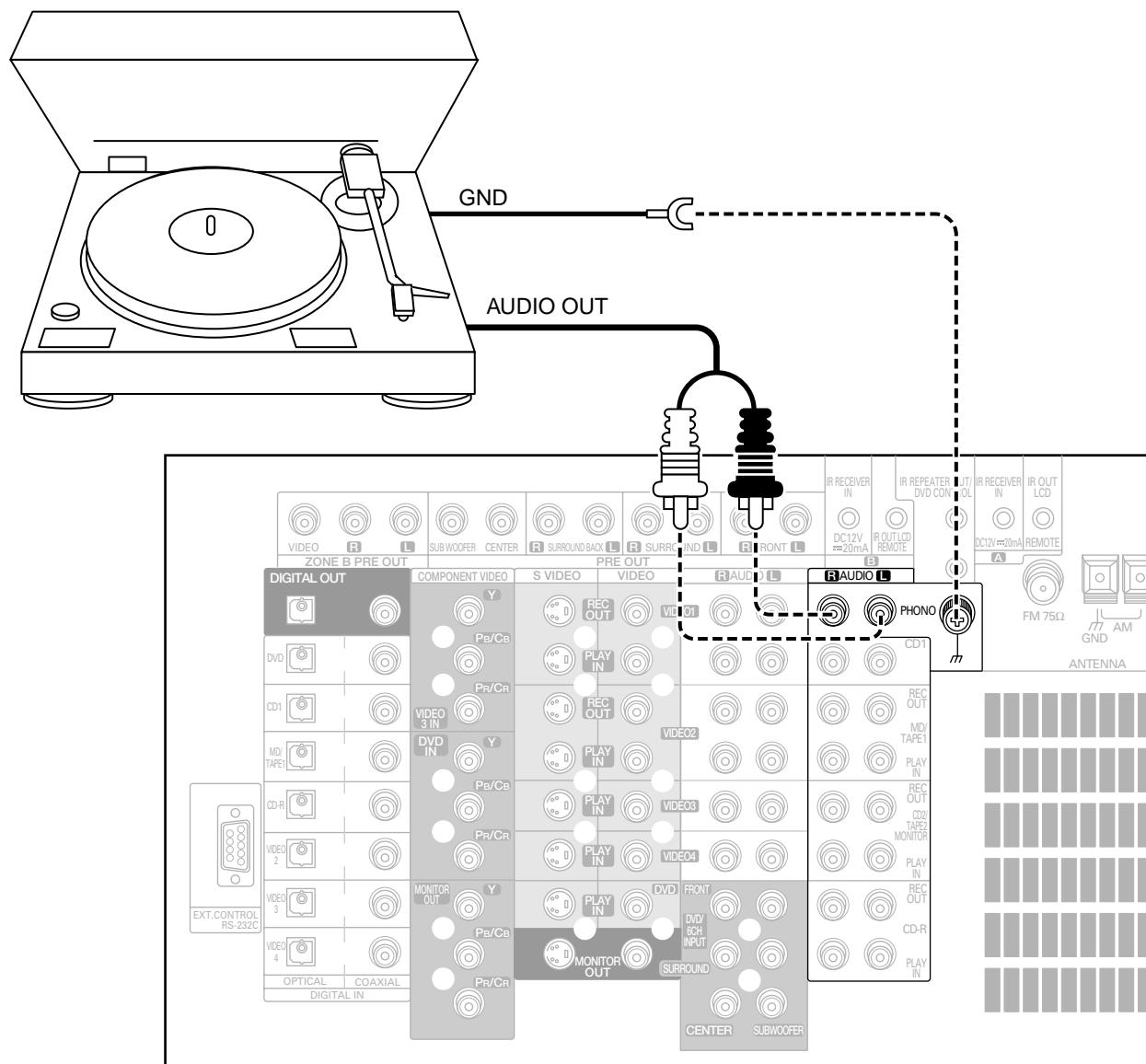

### NOTES

**Do not** plug in the receiver to AC power until you have connected all your devices.

This section focuses on the connections from your turntable/record player to the VR-5700/VR-5090/VR-5080. Please refer to your turntable/record player's instructions for more detail about its connection jacks and capabilities.

#### To Connect a Turntable/Record Player:

1. Connect the audio cables from the turntable audio output jacks to the receiver's **PHONO R** and **L** jacks.
2. If your turntable includes a ground cable, connect the ground cable to the receiver's  $\text{⏏}$  (ground) jack.

## Connecting a Camcorder or Additional VCR

This section focuses on the connections from your camcorder or VCR to the front of the VR-5700/VR-5090/VR-5080. Please refer to your camcorder or VCR's instructions for more detail about its connection jacks and capabilities.

These instructions describe how to connect a camcorder or VCR quickly and probably temporarily to the front of the receiver. If you want a less cluttered and more permanent connection, see "Can I Connect an Additional VCR Permanently?", below.

### To Connect a Camcorder or Additional VCR:

Connect the audio and video cables from the camcorder or VCR's Audio and Video jacks to the receiver's front panel jacks as shown to the left.

### Can I Connect an Additional VCR Permanently?

Yes. To do so, follow the instructions under "To Connect a Secondary VCR:" on page 15.

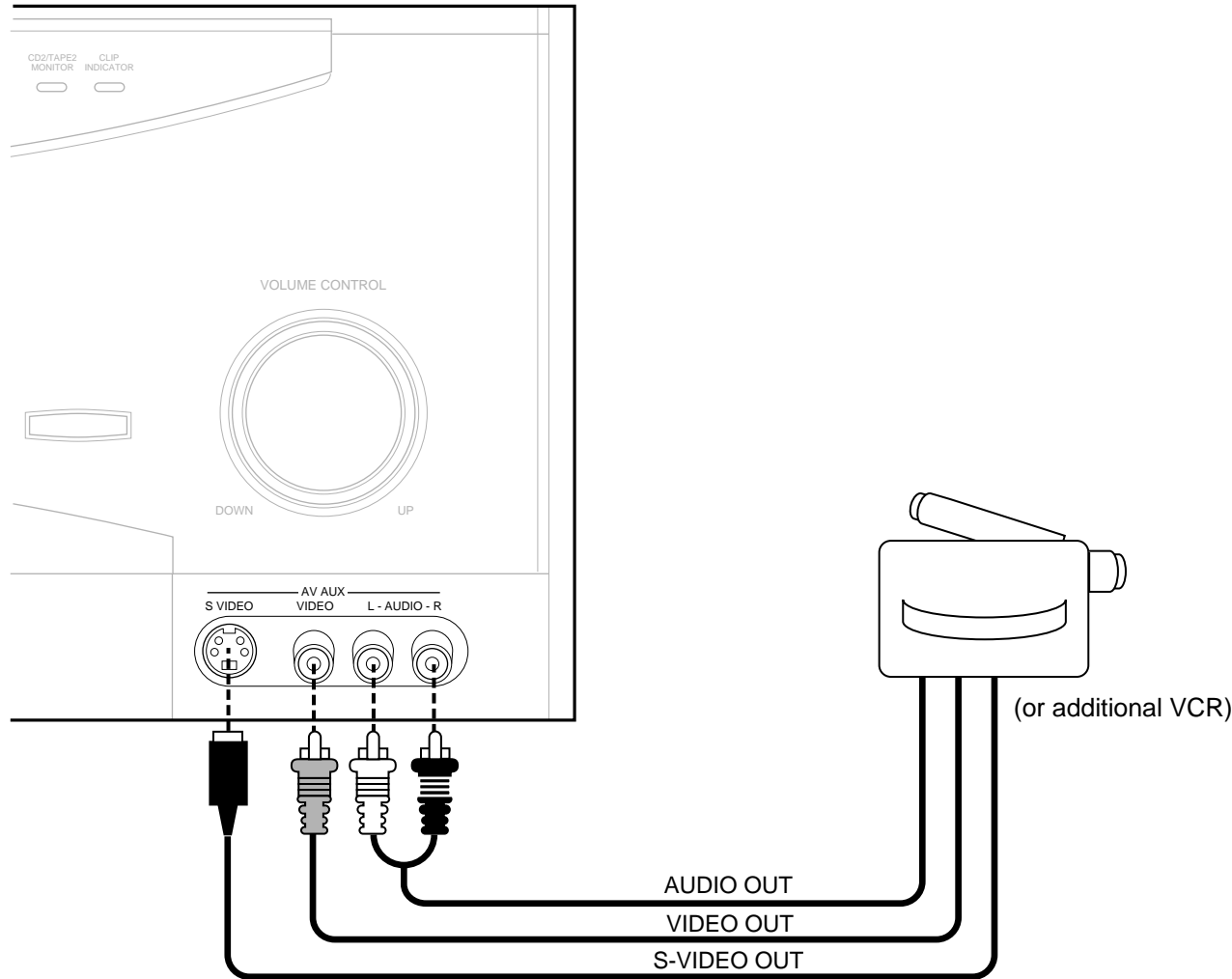

## What if I Have Several Kenwood Devices (System Control Chaining)?

Connecting system control cords after connecting a KENWOOD audio component system lets you take advantage of convenient system control operations.

This unit is compatible only with the [SL16] mode. The system control operation is not available if the unit is connected in the [XS8] connection mode.

If your component has a mode select switch, set the switch to the [SL16] mode.

- You can connect the system control cord to either system control jack of the unit.
- Do this operation after completing all connections. (Ensure that the power plug is not connected.)

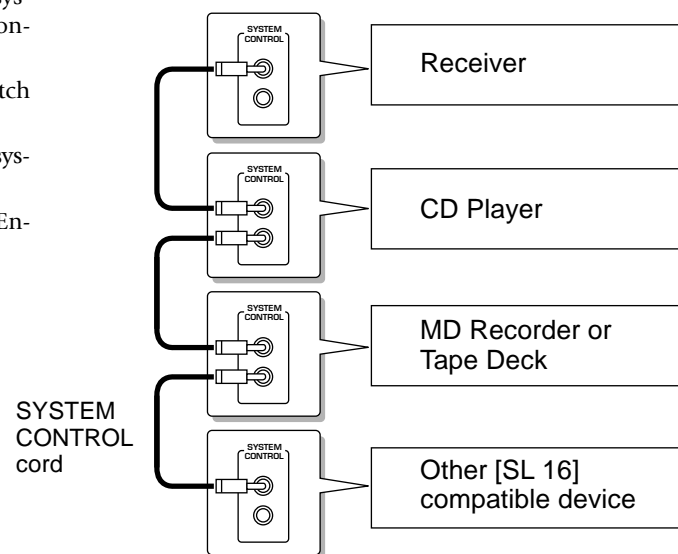

### NOTES

Make sure the units are connected to the correct jacks on the receiver—for example, no device connected to the **CD2/TAPE2 MONITOR** jacks can use a system control cable.

Some CD players and cassette decks do not support the SL16 system control mode. Do not include these devices in a set of chained connections.

**Do not** connect system control cables to any device not specified by Kenwood. Using a system control cable with a device that does not support them can damage the device.

Make sure system control plugs are firmly seated in the appropriate jacks.

#### System Control connection allows you to:

- control connected devices via Remote Control unit.
- See the current status of the selected source device, such as *Play* or *Stop* on Remote Control unit's display.
- switch the receiver's input automatically to a connected device when you start playback from that device
- synchronize recording a CD automatically when you start playback from the connected CD player

## Connecting the Antennas

### RF Remote Antenna

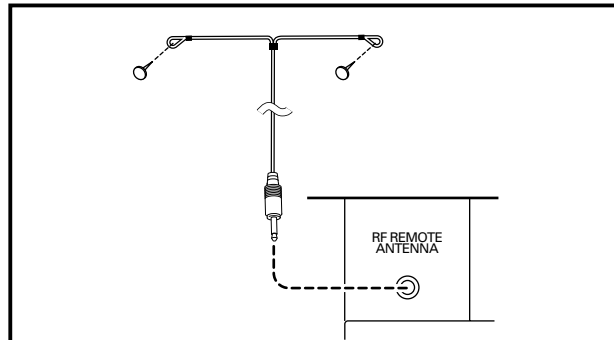

The Remote Control unit for the VR-5700/VR-5090/VR-5080 communicates with the receiver via RF transmission. To properly receive the RF remote signal, connect the provided RF Remote Antenna as described below.

1. Insert the jack of the provided RF Remote Antenna into the receiver's **RF REMOTE ANTENNA** jack.
  2. Distribute the antenna wire horizontally and fix it.
- Distribute the antenna away from the metallic panel.

### FM Indoor Antenna

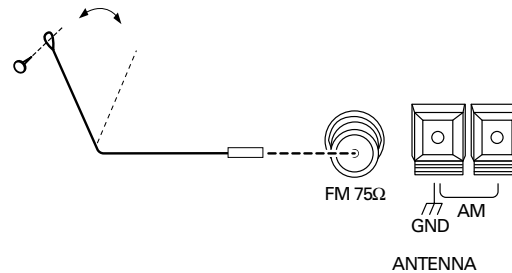

Your new receiver also comes with an FM indoor antenna for FM radio reception. To connect the FM antenna:

1. Attach the antenna sheath to the pole in the center of the receiver's FM antenna jack, as shown above. When you attach the sheath for the first time, you may need to exert quite a bit of pressure.
2. Adjust the antenna as necessary to improve reception.
3. Tack the looped end of the antenna in the location that provides the best reception.

### FM Outdoor Antenna

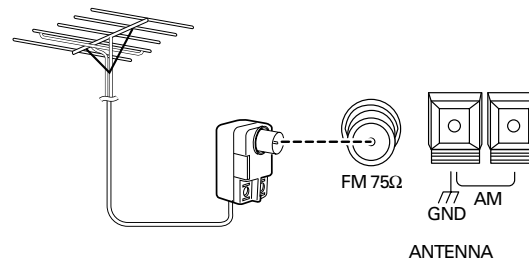

Kenwood recommends a permanently installed outdoor FM antenna for best FM reception. To connect an outdoor FM antenna:

1. Connect the antenna wire to a standard, commercially available antenna adapter as shown above.
2. Connect the adapter to the receiver's FM antenna jack.

### AM Loop Antenna

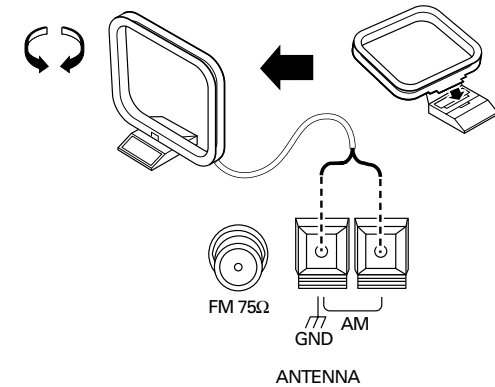

Your new receiver comes with an AM loop antenna for AM radio reception. To connect the AM antenna: **33**

1. Insert the antenna loop into the base and position the loop.
2. Open the receiver's antenna terminal levers.
3. Insert the antenna's wires into the terminal as shown above.
4. Close the antenna terminal levers to lock the wires in place.
5. Adjust the antenna loop as necessary to improve reception.

## NOTES

To prevent hum interference, keep the AM antenna wires away from speaker wires, AC power cords, the TV chassis, and the receiver.

### What if I Have Cable Radio?

If you have cable radio, contact your cable provider for assistance with connecting to the VR-5700/VR-5090/VR-5080.

## Chapter Two: Setting Up Remote Control Unit

This Remote Control unit can be set up to remote control the receiver as well as most of the devices connected to it.

The appearance and functions of the Remote Control unit are slightly different from other Remote Control units. Since it is used to remote control a large number of devices, its screen shows the information of each device in separate menus.

This Remote Control unit can remote control the devices which are connected to the receiver and identified by the Remote Control unit.

In case the Remote Control unit cannot remote control a device you want to use, check if the device has been registered for identification by the Remote Control unit. The method of registering devices in Remote Control unit will be described later in this chapter.

This chapter is composed of the following sections.

Installing the Batteries	Page 34
Resetting the Remote Control Unit	Page 34
Basic Operation of Remote Control Unit	Page 35
Setting Up Speakers	Page 36
Identifying Components for Remote Control Unit	Page 39

### Installing the Batteries

Before you can set up any Remote Control unit item, you need to install batteries.

- The batteries that came with your new Remote Control unit are intended for you to use for an operation check—they may not last as long as ordinary batteries. We recommend replacing them with batteries for normal use.

To install the batteries:

- Slide down the battery cover as shown by the figure to remove it.

- Insert four AA(R6) batteries with the correct polarity. Then close the battery cover.

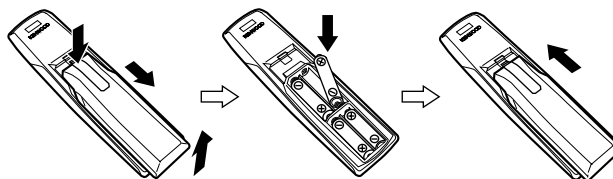

### NOTES

If Remote Control unit is used outside the remote control range, the screen may show erroneous information. For the remote control range, refer to page 7 ("Remote controllable range") in the *Users' Guide*.

When the remote control range reduces or the Low Battery indicator (🔋) will flash in the LCD screen, replace all of the four batteries together.

To extend the battery life, we suggest that you keep the backlight off except when necessary. For the backlight, refer to the *Users' Guide*.

### Resetting the Remote Control Unit



The Remote Control unit can be reset in two ways

#### To reset the remote without clearing the setups:

- Remove the batteries then reload them again.

This resets the Remote Control unit but the speaker setup and device setup remain unchanged.

#### To reset everything and initialize the remote to the factory condition:

- Remove the batteries.
- While holding the  (function up) button and  button simultaneously, load the batteries.

This operation resets all of the setups made by the user.

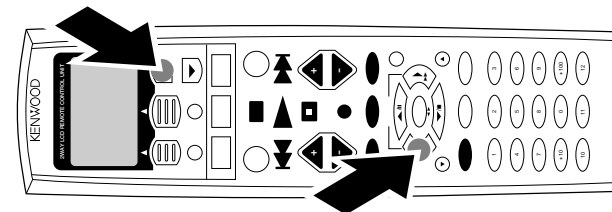



## Basic Operation of Remote Control Unit

Remote Control unit is a new type of Remote Control unit which receives information from the receiver and display it on the LCD screen.

This section describes the basic operations of Remote Control unit.

Turning power on:

To turn the receiver on: Press the **SYS.POWER** button.

To turn the connected device on: Press the **AV POWER** button.

(It is necessary to perform the procedure in "Identifying Components for Remote Control Unit" on page 39 to enable remote control of AV devices.)

### Selecting the input:

Audio device: Press the **MUSIC** button repeatedly. The input names where audio devices are identified by Remote Control unit will be shown on the LCD screen.

- ① CD1 :
- ② MD/Tape1 :
- ③ Tuner :
- ④ CD-R :
- ⑤ Phono :

If an audio device which is connected to an input is not identified by Remote Control unit, the device name is skipped and not displayed.

Video device: Press the **MOVIE** button repeatedly. The input names where video devices are identified by Remote Control unit will be shown on the LCD screen.

- ① Video1 :
- ② Video2 :
- ③ Video3 :
- ④ Video4 :
- ⑤ DVD/6ch :
- ⑥ AV AUX :

If a video device which is connected to an input is not identified by Remote Control unit, the device name is skipped and not displayed.

(VR-5080 only)

Although **Video4** is displayed in the initial status, the receiver cannot be switched to select **Video4**. The **Video4** display will not appear after the Remote Control unit has been set up.

TV: Press the **TV** button. The LCD screen shows TV if this is registered in and identified by Remote Control unit.

### Adjusting the receiver's volume:

Press the **VOL. (+/-)** button until the desired volume is obtained.

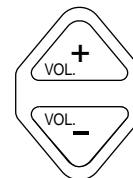

### Muting audio temporarily:

Press the **MUTE** button.

To resume the original volume, press the **MUTE** button again or press one of the **VOL. (+/-)** buttons.

### Using the numeric buttons:

When entering a figure directly for selecting a CD track number, etc., press the numeric buttons as shown below.

To enter 5 : **5**

To enter 25 : **+10** **+10** **5**

or

: **2** **5**

The button to be pressed varies depending on the function.

### Screen menu control operation

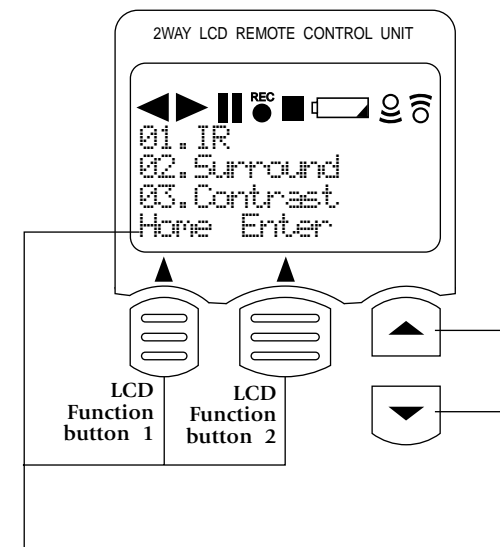

The contents of the function buttons vary according to current situations, and the function names (Next, Back, Enter, etc.) are shown on the screen.

For details, see the description of each control operation.

Press to select an item by scrolling the screen menu up or down.

The selected item is displayed in an inverted color.

Before you can begin using the receiver to control your home entertainment system, you must set up Remote Control unit to operate your speakers effectively. There are four areas of speaker setup:

- Selecting the Speakers
- Balancing the Speaker Volumes
- Bass Peak Level
- Adjusting the Speaker Distances

The receiver must be on and speakers must be connected before you can set up speakers.

### Speaker Placement

An example of installation is shown here. Use this figure as a reference for installing the system according to the types of your speakers and conditions of your listening room.

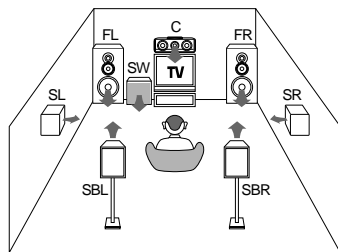

**FL/FR (Front speakers)** : Place to the front left and right of the listening position. Front speakers are required for all surround modes.

**C (Center speaker)** : Place front and center. This speaker stabilizes the sound image and helps recreate sound motion.

**SW (Subwoofer)** : Reproduces powerful deep bass sounds.

**SL/SR (Surround speakers)** : Place to the direct left and right, or slightly behind, the listening position at even heights, at least 3.3 ft (1 meter) above the ears of the listeners.

## Setting Up Speakers

**SBL/SBR (Surround back speakers)** : The SBL/SBR speakers are required to reproduce 6.1-channel signals (THX Surround EX, DTS-ES). Place them on the left and right behind the listening position and at the same height as the SL/SR speakers.

### Selecting the Speakers

1. Press the **POWER ON/STANDBY** button on the main unit to turn the power on.
2. Press the **MUSIC** button or **MOVIE** button to display the "Menu".

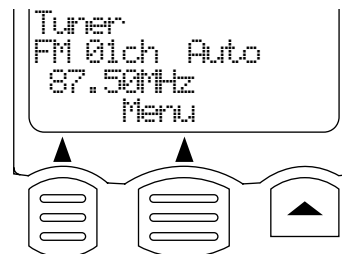

3. Press the **Menu** button (LCD function button 2).

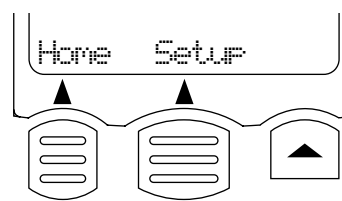

4. Press the **Setup** button (LCD function button 2).

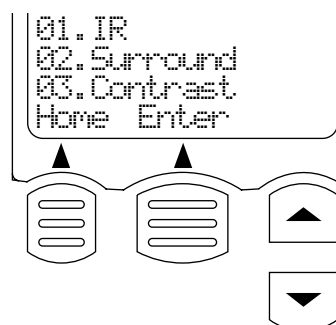

5. Press the LCD cursor up/down button (▲, ▼) to select "02. Surround", then press the **Enter** button (LCD function button 2)



6. Press the LCD cursor up/down button (▲, ▼) to select **Sub Woofer On** or **Off**, then press the **Next** button (LCD function button 2).

- If you selected **On** for the subwoofer, all of the bass below 80Hz is removed from all other **Nml** (Normal)/**THX** setting speakers in your system and is sent to the subwoofer in all listening modes. This improves your speakers' power handling and reduces overall distortion.

- If you selected **Off** for the subwoofer, the bass tone is removed from all other **Nml/THX** setting speakers in your system and is sent to the front L and R speakers.

To abort setup, press the **MUSIC** button, **MOVIE** button or **Home** button.

Select **Nml/THX** for the speaker for use in THX reproduction.

7. When the front (left and right) speaker setting menu (**Front**) appears, select **Front Nml** (Normal)/**THX** or **Large** in the same way as step 6, then press the **Next** button. (If you set the subwoofer to **Off** in step 6, skip this step.)

8. When the center speaker setting menu appears, select **Center Nml/THX, Large** or **Off** in the same way as step 6, then press the **Next** button. Select **Off** when no center speaker is connected. (If you select **Nml/THX** in step 7. "Large" cannot be selected here.)
  9. When the surround (left and right) speaker setting menu (**Surround**) appears, select **Surround Nml/THX, Large** or **Off** in the same way as step 6, then press the **Next** button. Select **Off** when no surround speaker is connected. (If you select **Nml/THX** in step 7. "Large" cannot be selected here)
  10. When the surround back (left and right) speaker setting menu (**Sur. Back**) appears, select **Sur. Back Nml/THX, Large** or **Off** in the same way as step 6, then press the **Next** button. Select **Off** when no surround back speaker is connected. (If you select **Nml/THX** in step 7. "Large" cannot be selected here. If you select the surround to **Off** in step 9, skip this step and surround back speakers select Off automatically.)
    - Select **Nml/THX** if the speaker is not capable of producing clean, deep bass energy at output levels that match those produced by a typical powered subwoofer. All bass below 80Hz in that channel is removed from that speaker and is sent to the subwoofer (or sent to the front speakers if subwoofer is set to off) in all listening modes. Most speakers should be considered **Nml/THX**.
- If you have THX certified speakers, select the Nml setting.
- Select **Large** if the speaker is capable of producing clean, deep bass energy at output levels that match those produced by a typical powered subwoofer. All bass below 80Hz in that channel is left in that speaker in all listening modes.

NOTE : If you set the front or center speaker to **Large**, the subwoofer may not output audio depending on the setups of the input signal, speakers and listen mode.

Speaker combinations that can be selected with custom setup

Subwoofer	Front speakers	Center speaker	Surround speakers	Surround back speakers
On	Nml/THX →	Nml/THX → Off →	Nml/THX → Off →	Nml/THX Off
	Large →	Nml/THX → Large → Off →	Nml/THX → Large → Off →	Nml/THX Large Off
Off	Large →	Nml/THX → Large → Off →	Nml/THX → Large → Off →	Nml/THX Large Off
		Nml/THX → Large → Off →	Nml/THX → Large → Off →	Nml/THX Large Off

11. If you have a subwoofer as part of your home theater speaker system and have set your left & right front speakers to **Large**, **SW Re-Mix** mode gives you the flexibility to choose how bass information is distributed to your speakers. (As mentioned above, most speakers will perform best when set to **Nml/THX**.)  
 If the **Re-Mix Off-THX** option is selected, bass from the front left and front right channels will go ONLY to the front left and front right speakers. The subwoofer will only receive a bass signal from the LFE channel of Dolby Digital and DTS programs, and from any channels with speakers that you have designated as Nml/THX. *This selection is preferred by THX.*  
 If the **Re-Mix On** option is selected, you will send the bass from the front left and right channels to the front left & right speakers AND the subwoofer simultaneously. While this setting keeps your subwoofer active in all listening modes, it can also cause the bass to sound indistinct (or "muddy") because it is now coming from up to 3 different speakers at once.  
 If your home theater speaker system includes a subwoofer and you have set your front left & right speakers to 'Large', we suggest that you initially use the **Re-Mix Off-THX** setting. If this produces weak-sounding bass in your room, change to the **Re-Mix On** setting.
12. Press the **Next** button to proceed to the "Balancing the Speaker Volumes" setting below.  
 To quit setting and return to the normal operation screen, press the **Home** button.

NOTE: When activating the THX operation, it is recommended to set **SW Re-Mix Off-THX** so that the THX operation can match correctly the human sense of audition.

### Balancing the Speaker Volumes

In this step you will balance the volume levels of all the system's speakers except the subwoofer for your room and listening position. (To set the subwoofer level, see "Setting the Subwoofer Level" on page 38.) When all the speakers are set at the same volume level, your system will create a more realistic, spacious surround sound environment.

You can balance the speakers by ear, or you can use a sound level meter. Using a meter lets you balance your system more accurately, and lets you set the reference playback level. (See "Balancing the Speaker Levels with a Sound Level Meter" on page 42)

#### When setting the speaker levels, be careful against the high-level test tone that is produced.

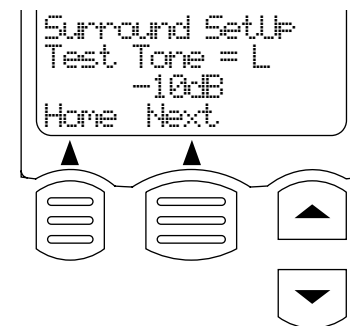

1. Minimize external noise in the listening room.
2. Position yourself in a place where you usually listen to music or view video.
3. In step 12 of the "Selecting the Speakers" setting procedure above, press the **Next** button (LCD function button 2)
4. "Test Tone = Off" appears on the display.
5. Press the LCD cursor up/down button (▲, ▼) to select **On**, then press the **Next** button (LCD function button 2)



## Chapter Two : Setting Up the Remote Control Unit

- Test noise is generated from the front left speaker. Listen to the volume of the noise carefully.

The test noise moves from a speaker to the next speaker every about 2 seconds. The test noise does not move while a control is manipulated.

- Listen to the test noise level carefully. If the noise level from the center speaker differs from that from the front left speaker, press the  or  button to make the noise level equal. (Do not adhere to the displayed volume levels because they are provided for mere references. Use your own ears to check if the levels from two speakers are identical or not.)
- Set the reproduce levels of all the speakers in the system in the same way as above.
- Press the **Next** button to proceed to the "Bass Peak Level" setting below.

To quit setting and return to the normal operation screen, press the **Home** button.

**Setting the Subwoofer Level:** Because of the way humans hear, the test noise the Speaker Level menu sends through the subwoofer will not sound as loud as it really is. (The Speaker Level menu subwoofer test noise is designed to be used with a sound pressure level meter for balancing. See "Balancing the Speaker Levels with a Sound Level Meter" on page 42)



Because of this, you cannot use that test noise to properly calibrate the level of your subwoofer by ear. To set the subwoofer level, listen to familiar music or films that have strong bass content and adjust the subwoofer level until it sounds balanced with the rest of the speakers.

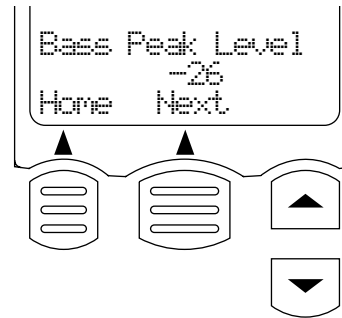

### Bass Peak Level

The LFE (bass effects) channel of Dolby Digital and DTS programs can contain up to 10dB more energy than the other channels, which is enough to damage some speakers. The VR-5700/VR-5090/VR-5080 has a bass limiter circuit that keeps the output to your subwoofer (or left & right speakers, if your system doesn't have a subwoofer) within safe limits.

- In step 9 of the "Balancing the Speaker Volumes" setting procedure above, press the **Next** button (LCD function button 2)



- Press the LCD cursor up or down button ( or ) , then "-30 dB" appears on the display.
  - The test tone is output and its level is set automatically to -30 dB.
- The level of the test tone is not affected by the current setting of the volume control.

- Press the LCD cursor up/down button ( / ) to adjust the speaker level at a level just before the audio starts to be distorted.
- Press the **Next** button to proceed to the "Adjusting the Speaker Distances" setting below.

To quit setting and return to the normal operation screen, press the **Home** button.



Do not output the test tone for a long period while the speaker audio is distorted.



### Adjusting the Speaker Distances

Measure the distance from each speaker to the seat you most often use. Note the distance in the table below:

Speaker	Distance (ft or m)
Front left	
Center	
Front right	
Surround right	
Surround back right	
Surround back left	
Surround left	
Subwoofer	

- In step 5 of the "Bass Peak Level" setting procedure above, press the **Next** button (LCD function button 2).



- Set the distance of the L (left front) speaker using the  or  button.
- Press the **Next** button and set the distance of the next speaker (C = Center) speaker.
- Set the distances of all the speakers in the system.
  - R: Right Front speaker
  - SR: Surround Right speaker
  - SBR: Surround Back Right speaker
  - SBL: Surround Back Left speaker
  - SL: Surround Left speaker
  - SW: Subwoofer

The speakers that are set to "Off" in "SP Selection" are not displayed.
- Press the **Home** button (LCD function button 1) to return to the normal operation screen.

## Identifying Components for Remote Control Unit

After the speaker setup, it is required to make Remote Control unit capable of identifying the devices it controls. Remote Control unit provided with the receiver can be used in setup of any device. Even when a device is not listed in the device codes in the Remote Control unit memory, the remote control function of the device can be programmed using the Learn function.

The Learn function can also be used to extend the remote controllable functions.

For details, see "If a device cannot be remote controlled with any code in the list, or to add remote control target functions..." on page 40.

### Registering a device

1. Ensure that the batteries are loaded.

Press the **MUSIC** button or **MOVIE** button to display "Menu".

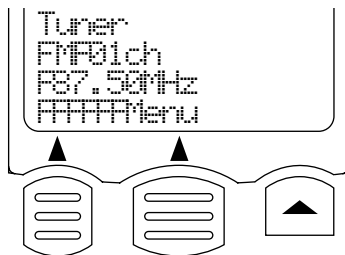

2. Press the **Menu** button (LCD function button 2).

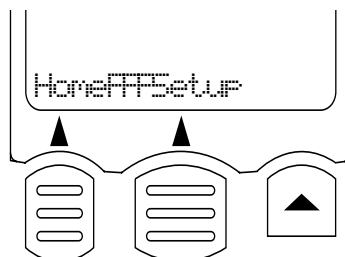

3. Press the **Setup** button (LCD function button 2).

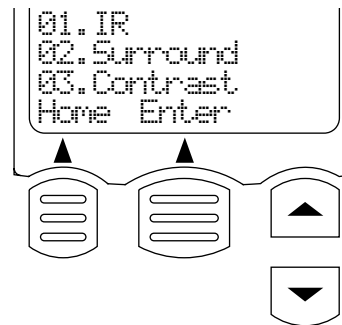

4. Select "01. IR" using the **Up** or **Down** button, then press the **Enter** button (LCD function button 2).

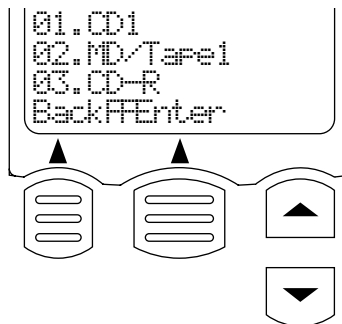

5. See "Noting Your Devices" on page 3 to check the devices and the jacks to which they are connected.
6. Select a device connection jack name (CD1, MD/Tape1, etc.) using the **Up** or **Down** button, then press the **Enter** button (LCD function button 2).

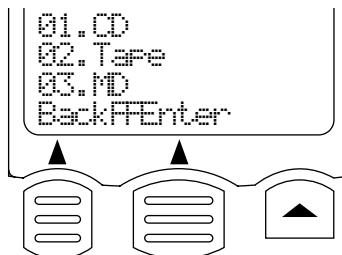

7. Select the device name connected to the jack (CD, Tape, etc.) using the **Up** or **Down** button, then press the **Enter** button.

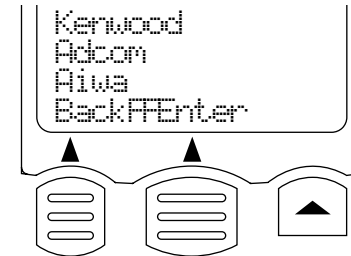

8. Select the manufacturer name of the device using the **Up** or **Down** button, then press the **Enter** button.

If the manufacturer name of the device is not listed, select "Nothing" and press the Enter button. In this case, the code can be programmed using the Learn function (see page 40).

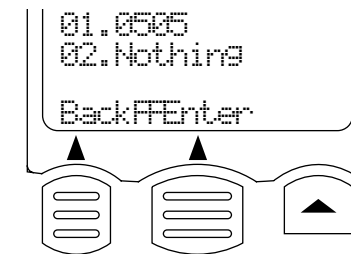

9. Select the setup code of the device (each device has a remote control identification number matching it) using the **Up** or **Down** button.

- When the device is connected through a Kenwood system control cord, select **System**. In this case, the remote control signal is sent to the receiver then to the device connected to it.

10. Press the **AV POWER** button.

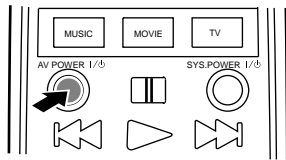

Pressing the **AV POWER** button causes Remote Control unit to transmit the signal turning on/off the device being set. The device is turned on if the selected setup code is correct. If it is not turned on, select another code and press the **AV POWER** button again. In case it cannot be turned on by any code, see "If a device cannot be remote controlled with any code in the list, or to add remote control target functions..." on this page.

Skip this step if **System** is selected in the setup code selection.

- 40 11. After ensuring that the setup code is correct, press the **Enter** button.
12. The display in step 4 re-appears.
- Set other devices by repeating steps 5 to 12 for each of them.

**To change a setup code:**

When a new device is purchased to replace the previously connected device, it is required to let Remote Control unit identify the new device as described below.

1. Connect the new device (see pages 3 to 32).
2. Perform the procedure in "Identifying Components for Remote Control Unit" on page 39 to select the jacks of the new device and enter a new setup code. The newly selected code replaced the previous code at the moment the **Enter** button is pressed to save the new code.

**To delete a setup code:**

When a device is disconnected and no replacing device is connected, it is required to remove the setup code from this Remote Control unit memory as described below.

1. Perform the procedure in "Identifying Components for Remote Control Unit" on page 39 to select the jacks where the disconnected device was connected.

2. In step 6, select "Delete", "No Type" or by scrolling the device names. This makes Remote Control unit no longer identify the device.

- If you select **Delete**, the setup is deleted together with the input name. For example, once you delete **VIDEO1 to VIDEO3**, the **VIDEO1 to VIDEO3** inputs are skipped even when they are selected.
- If you select **No Type**, the input name is displayed but only the registered device name is deleted.

**If a device cannot be remote controlled with any code in the list, or to add remote control target functions...**

This Remote Control unit incorporates an advanced Learn function which makes it possible to program remote control signals used by another Remote Control unit in itself. If the setup code of a connected device is not contained in the Remote Control unit memory, program the code in Remote Control unit using this function.

This function can also be used to change a setup code or add extended function to the remote control target.

- Up to five extended functions per device can be programmed additionally in this Remote Control unit using "Extend1" to "Extend5" displayed on the LCD screen.
- The remote control signals transmitted by this Remote Control unit buttons can be changed. The signals from the buttons painted black in the following figure can be modified.

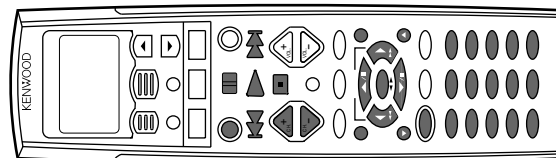

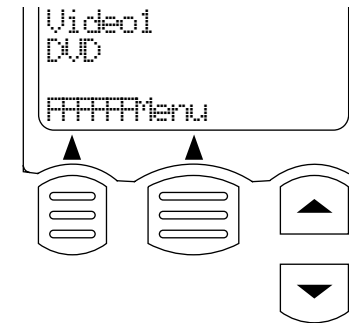

To program new functions in Extend1 to Extend5:

1. Select the controlled device (CD, DVD, etc.) by pressing the **MUSIC**, **MOVIE** or **TV** button.

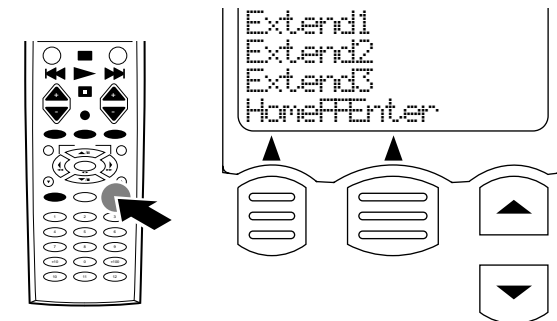

2. Press the **LEARN** button.



3. Select one of Extend1 to Extend5 using the  or  button, then press the **Enter** button (LCD function button 2).

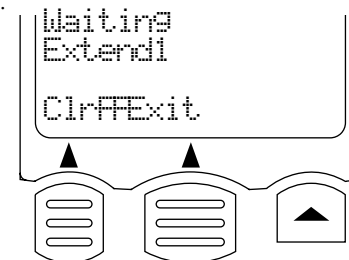

## Chapter Two : Setting Up the Remote Control Unit

Press the **Exit** button (LCD function button 2) to exit from the operation.

Press the **Clr** (clear) button (LCD function button 1) if you want to clear the previously programmed remote control signal and reset to the factory shipment condition. (Cleared is displayed.)

- To program remote control signal, place the two units opposite to each as shown below. On the Remote Control unit of the selected device, press the button transmitting the desired remote control signal. Complete is displayed when the remote control signal has been programmed in this Remote Control unit.

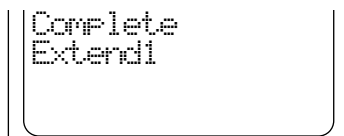
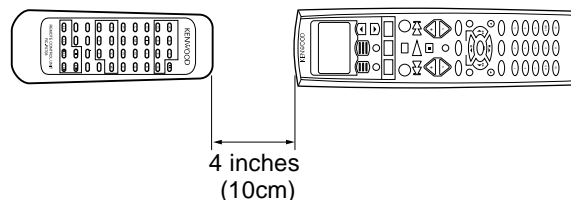

- "Error" is displayed when it failed.

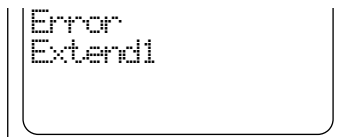

- To program other remote control signals, repeat steps 1 to 4 for each.

**To change the remote control signal from a Remote Control unit button (When you select "Nothing" in step 8 on page 39):**

- Select the controlled device (CD, DVD, etc.) by pressing the **MUSIC**, **MOVIE** or **TV** button.

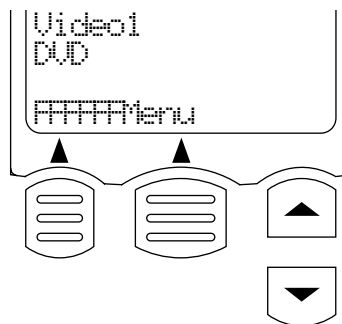

- Press the **LEARN** button.

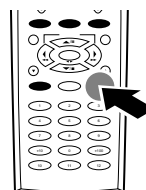

- On the Remote Control unit, press the button you want to change the function.

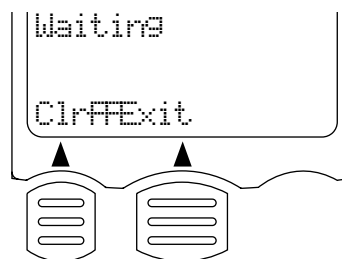

Press the **Exit** button (LCD function button 2) to exit from the operation.

- On the Remote Control unit of the selected device, press the button transmitting the desired remote control signal. Complete is displayed when the remote control signal has been programmed in this Remote Control unit.

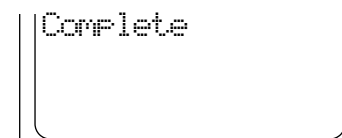

- To program other remote control signals, repeat steps 1 to 4 for each.

To reset a button to the factory shipment condition by clearing the previously programmed signal:

Press the **Clr** button in step 3 of the procedure above. (Cleared is displayed)



The remote control signal activated by holding the **F.SHIFT** button cannot be modified.

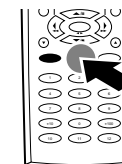

example:

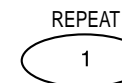

"REPEAT" function cannot be modified.

In programming a remote control signal, be sure to use the Remote Control unit originally provided with the AV device.

## Balancing the Speaker Levels with a Sound Level Meter

Note: These instructions assume you are using a Radio Shack SPL meter, model 33-2050.

1. Eliminate as many external noise sources as possible
2. Sit in the place where you and your guests will sit while watching movies or listening to music
3. Press the **MUSIC** button or **MOVIE** button to display the "Menu".

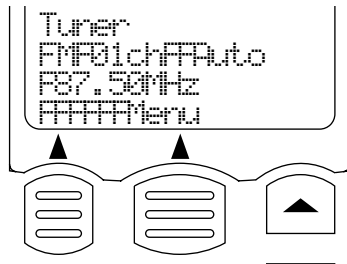

4. Press the **Menu** button (LCD function button 2).
6. Press the LCD cursor up/down button (▲, ▼) to select "02. Surround", then press the **Enter** button (LCD function button 2)

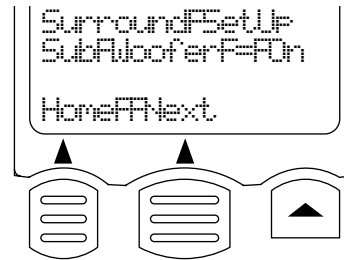

7. Press the **Next** button (LCD button 2) repeatedly until "Test Tone = Off" is displayed.
8. Press the LCD cursor up/down button (▲, ▼) to select "On", then press the **Next** button (LCD function button 2)

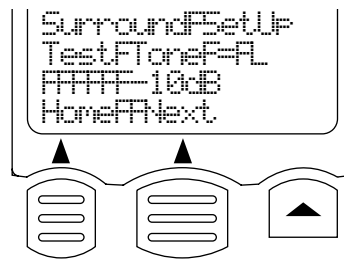

9. The receiver's volume control will automatically be set to 0dB and test noise will play from the front left speaker. Listen to the volume of the noise carefully. The test noise moves from a speaker to the next speaker every about 2 seconds. The test noise does not move while a control is manipulated.
10. On the SPL meter, choose 70dB on the large dial, and set the meter controls to "C" and "Slow".

11. Hold the meter at arm's length and ear height. press the ▲ or ▼ button to adjust the speaker's level so that the needle on the meter points between 4 and 6 (75dB). You can adjust the speaker's level by 1dB each time you touch one of the buttons.
12. Repeat step 11 for each speaker in the system (including the subwoofer).
13. When all of the speakers in the system play the test noise at 75dB on the SPL meter, press the **Next** button. To quit setting and return to the normal operation screen, Press the **Home** button .

### Reference Playback Level

Your system will now play carefully-transferred film soundtracks at the volumes intended by their makers when you set the receiver's volume control to 0dB. You can, of course, set the volume level to your own preferences.

- 42 4. Press the **Menu** button (LCD function button 2).

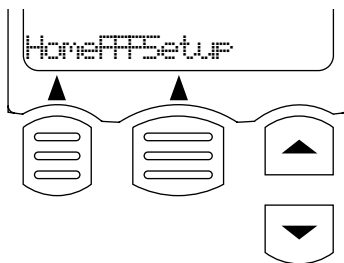

5. Press the **Setup** button (LCD function button 2).

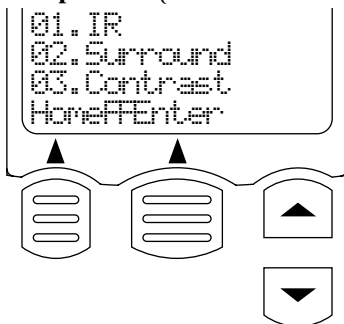



## RF Remote Control Function

### Changing the RF Transmission Frequency

The RF remote function may be affected by radio interference, etc. In this case, the transmission frequency can be changed.

To change the RF remote transmission frequency:

1. Open the battery cover on the rear.

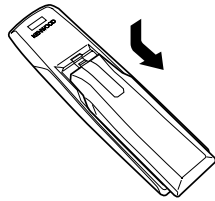

2. Change the RF switch setting.

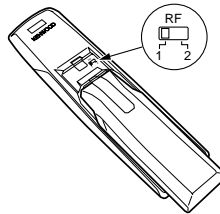

After changing Remote Control unit's RF frequency, you also must change the receiver's RF reception frequency.

3. To change the receiver's RF reception frequency.
  - Press and hold the **RF BAND** button (**TAPE2/CD2 / MONITOR** button) behind the receiver's panel door for more than 2 seconds. Each time you do this, it switches the RF reception frequency as follows.

- ① "RF BAND 1"
- ② "RF BAND 2"

Select the same number as the position number of the RF switch of the Remote Control unit.

### NOTES

The control distance of the RF remote signal is about 30 ft (10 meters) provided there is no obstacle.

The following factors can maximize the operation of your Remote Control unit.

1. Aim Remote Control unit toward the area where the receiver is located.
2. Do not position the receiver near metal (such as heat ducts). Metal can absorb RF signals.
3. Make sure the batteries in Remote Control unit are fully charged. Weak batteries will affect the range of Remote Control unit.
4. Make sure that Remote Control unit's range is not being affected by other radio frequency transmissions.
5. Position the RF antenna to achieve maximum RF range.

The tests for range limits of the Remote Control unit and the Receiver were conducted in open-air distance tests. Actual distance of the signal will be based on the construction of the building the unit is being used in as well as other factors such as outside RF interference.

## Chapter Three: Using Receiver's Front Panel to Set Up the Speakers

You can also perform the Speaker Setup and program pre-set radio stations using the receiver's front panel. (If you have already set up the speakers or programmed radio stations using Remote Control unit you don't have to repeat the procedures using the front panel.)

Since you still must use Remote Control unit to identify and set up your source devices for control, we recommend that you use it for all setup procedures.

- Do not operate Remote Control unit while you are performing Speaker Setup on the receiver's front panel.

### Preparation for setup

Most of the front panel control buttons are located inside the panel door. Make the following preparation for setup on the receiver. Open the panel door by pushing the lower part of the panel door.

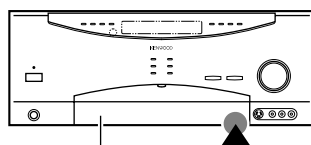

Panel door

Push the lower part of the panel door.

### Speaker Setup

- Press the **SET UP** button (**SOUND** button) until **SUBWOOFER ON** appears on the receiver's display (for more than 2 seconds).
  - If your system has a powered subwoofer, leave the receiver set this way and proceed to step 2.
  - If your system does not have a powered subwoofer, press either **MULTI CONTROL** ( $\nabla/\Delta$ ) button once. The receiver's display will read **SUBWOOFER OFF**.
- Press the **SET UP** button once more. The receiver's display will read **FRONT NML/THX**.

Button layout

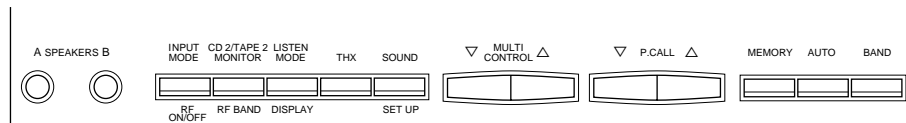

- If your left and right front speakers are not capable of producing clean, deep bass energy at output levels that match those produced by a typical powered subwoofer, leave the receiver set this way and proceed to step 3. (Most left and right speakers should be considered **NML/THX**.)
- If your left and right speakers are very large, and capable of reproducing clean, deep bass energy at output levels that match those produced by a typical powered subwoofer, press either **MULTI CONTROL** ( $\nabla/\Delta$ ) button once. The receiver's display will read **FRONT LARGE**.

NOTE: If you set your front speakers to **LARGE**, the subwoofer may not output audio depending on the setups of the rest of the speakers, the input signal and the listen mode. See step 6.

- Press the **SET UP** button once more. The receiver's display will read **CENTER NML/THX**.
  - If your center speaker is not capable of producing clean, deep bass energy at output levels that match those produced by a typical powered subwoofer, leave the receiver set this way and proceed to step 4. (Just about all center speakers should be considered **NML/THX**.)
  - If your center speaker is very large, and capable of reproducing clean, deep bass energy at output levels that match those produced by a typical powered subwoofer, press either **MULTI CONTROL** ( $\nabla/\Delta$ ) button repeatedly until the receiver's display reads **CENTER LARGE**.
  - If your speaker system doesn't have a center speaker,

press either **MULTI CONTROL** ( $\nabla/\Delta$ ) button repeatedly until the receiver's display reads **CENTER OFF**.

NOTE: If your front speakers are set to **NML/THX**, you can only set the center speaker to **NML/THX** or **OFF**.

- Press the **SET UP** button once more. The receiver's display will read **SURR NML/THX**.
  - If your surround speakers are not capable of producing clean, deep bass energy at output levels that match those produced by a typical powered subwoofer, leave the receiver set this way and proceed to step 5. (Just about all surround speakers should be considered **NML/THX**.)
  - If your surround speakers are very large, and capable of reproducing clean, deep bass energy at output levels that match those produced by a typical powered subwoofer, press either **MULTI CONTROL** ( $\nabla/\Delta$ ) button repeatedly until the receiver's display reads **SURR LARGE**.
  - If your speaker system doesn't have surround speakers, press either **MULTI CONTROL** ( $\nabla/\Delta$ ) button repeatedly until the receiver's display reads **SURR OFF**.

NOTE: If your front speakers are set to **NML/THX**, you can only set the surround speakers to **NML/THX** or **OFF**.
- Press the **SET UP** button once more. The receiver's display will read **S.BACK NML/THX**.
 

NOTE: If your surround speakers are set to **OFF**, the surround back speakers are automatically set to **OFF** and the receiver skips to step 6.

## Chapter Three: Using Receiver's Front Panel to Set Up the Speakers

A. If your surround back speakers are not capable of producing clean, deep bass energy at output levels that match those produced by a typical powered subwoofer, leave the receiver set this way and proceed to step 4. (Just about all surround back speakers should be considered **NML/THX**.)

B. If your surround back speakers are very large, and capable of reproducing clean, deep bass energy at output levels that match those produced by a typical powered subwoofer, press either **MULTI CONTROL** ( $\nabla/\Delta$ ) button repeatedly until the receiver's display reads **S.BACK LARGE**.

C. If your speaker system doesn't have surround back speakers, press either **MULTI CONTROL** ( $\nabla/\Delta$ ) button once. The receiver's display will read **S.BACK OFF**.

NOTE: If your front speakers are set to **NML/THX**, you can only set the surround back speakers to **NML/THX** or **OFF**.

6. Press the set up button once more. The display will read **SW RE-MIX OFF**.

NOTE: If your subwoofer is set to off, **SW RE-MIX** is automatically set to off and the receiver skips to the next setup.

If you have a subwoofer as part of your home theater speaker system and have set your left and right front speakers to **FRONT LARGE**, **SW RE-MIX** mode gives you the flexibility to choose how bass information is distributed to your speakers. (As mentioned previously, most speakers will perform best when set to **NML/THX**.)

7. Use the **MULTI CONTROL** ( $\nabla/\Delta$ ) buttons to select the desired **SW RE-MIX** mode:

- If **SW RE-MIX OFF** is selected, bass from the front left and front right channels will go **ONLY** to the front left and front right speakers. The subwoofer will only receive a bass signal from the LFE channel of Dolby Digital and DTS programs, and from any channels with speakers that you have designated as **NML/THX**. This selection is preferred by **THX**.
- If **SW RE-MIX ON** is selected, you will send the bass from the front left and right channels to the front

left and right speakers AND the subwoofer simultaneously. While this setting keeps your subwoofer active in all listening modes, it can also cause the bass to sound indistinct (or "muddy") because it is now coming from up to 3 different speakers at once.

If your home theater speaker system includes a subwoofer and you have set your front left and right speakers to **FRONT LARGE**, we suggest that you initially use the **SW RE-MIX OFF** setting. If this produces weak-sounding bass in your room, change to the **SW RE-MIX ON** setting.

8. Balancing the speaker volumes

You can use your ears to adjust the volume balance between the speakers in the system. See page 37 for details.

A. Minimize external noise in the listening room.

B. Position yourself in a place where you usually listen to music or view video.

C. Press the **SETUP** button repeatedly until "TEST TONE OFF" is displayed.

D. Press the **MULTI CONTROL** ( $\nabla/\Delta$ ) button to select **ON**, then press the **SETUP** button.

**When setting the speaker levels, be careful against the high-level test tone that is produced.**

The speaker volume adjustment display appears and test noise is generated from the front left speaker ("L 0 dB" displayed). Listen to the volume of the noise carefully.

E. When the test noise moves to the center speaker and "C 0 dB" is displayed, adjust the volume to the same level as the front left speaker by pressing the **MULTI CONTROL** ( $\nabla/\Delta$ ) button.

F. Similarly, adjust the volumes of the "R" (front right), "SR" (surround right), "SBR" (surround back right), "SBL" (surround back left) and "SL" (surround left) speakers.

Do not adjust the "SW" (Subwoofer) volume using the test noise. It should be adjusted while listening to ordinary music.

G. Press the **SET UP** button once more. The receiver's display will read **BASS PEAK OFF**.

Since the LFE (bass effects) channel of Dolby Digital and DTS programs can contain up to 10dB more energy than the other channels, which is enough to damage some speakers. The VR-5700/VR-5090/VR-5080 has a bass limiter circuit that keeps the output to your subwoofer (or left and right speakers, if your system doesn't have a subwoofer) within safe limits.

H. Press either **MULTI CONTROL** ( $\nabla/\Delta$ ) button. You will hear the bass peak test tone, and the display will read -30dB. (The test tone level is not affected by the receiver's volume control.)

I. Press the **MULTI CONTROL** ( $\Delta$ ) button slowly and repeatedly to increase the speaker volume until you just begin to hear audible distress from the woofer (distortion, clicking, "bottoming").

J. Press the **MULTI CONTROL** ( $\nabla$ ) button once or twice to decrease the speaker volume to the level just before the distress began.

K. Press the **SET UP** button to save the setting and proceed to "Setting the speaker distances" below.

9. Setting the speaker distances

Measure the distance between each speaker and the listening position you frequently use. See page 38 for details.

A. After step K in procedure 8 above, the speaker distance setting display appears.

B. When "L 3.0m/10ft" is displayed, correct the distance of the front left speaker from you using the **MULTI CONTROL** ( $\nabla/\Delta$ ) button.

C. Press the **SET UP** button to display "C 3.0m/10ft" and correct the distance of the center speaker from you using the **MULTI CONTROL** ( $\nabla/\Delta$ ) button.

D. Similarly, set the distances of the "R" (front right), "SR" (surround right), "SBR" (surround back right), "SBL" (surround back left), "SL" (surround left) and "SW" (Subwoofer) speakers.

E. Press the **SET UP** button repeatedly until "SETUP FIXED" is displayed.

## Chapter Four: Setting Up Multiple Zones

The VR-5700/VR-5090/VR-5080 offers dual-zone output and control, which enables you to use a single receiver to control devices and speakers for two zones (rooms). Due to its advanced features and controls, you can play music in one zone while watching a movie in the other!

Depending on your tastes and budget, you can set up one of the following "sound scenarios" to make full use of the Receiver's capabilities:

**No additional amplifier for Zone B:** You can use the Receiver's Speaker B output for Zone B. This allows you to listen to full surround sound in Zone A only, or in stereo in Zone A when Zone B is active. The sound in Zone B will always be in stereo.

**Stereo amplifier for Zone B:** You can use an additional stereo amplifier for Zone B (connected to the Receiver's Zone B Preouts). This allows you to listen to full surround sound

in Zone A even if you are also listening in Zone B. The sound in Zone B will always be in stereo.

Multiple zones require you to run wires and cabling from the primary zone (Zone A) where your Receiver is installed to another zone (Zone B) where an IR Receiver, a second set of speakers, and possibly a second TV/Monitor is installed:

ZONE A  
(Main System)

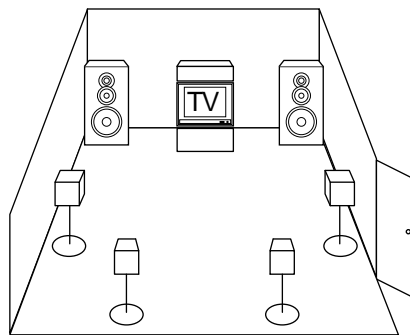

ZONE B

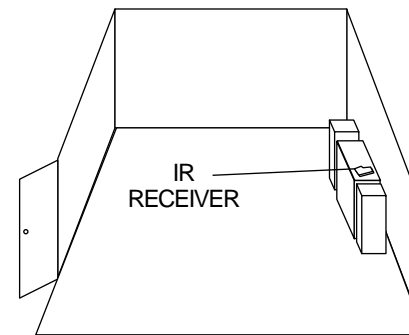

This chapter discusses some of the connection configurations and additional Remote Control unit setup necessary if you want to take full advantage of the Receiver's multiple-zone capabilities. It contains the following sections:

- Making Connections page 47
- Connecting the External Infrared Receivers and IR Repeaters page 48

### NOTES

To control the receiver from Zone B an optional IR receiver is required (see "Connecting the External Infrared Receivers and IR Repeaters" on page 48).

The optional Kenwood IR-9991 makes full use of Remote control unit's bi-directional communication capability.

If you plan on using the VR-5700/VR-5090/VR-5080 in a Dual-Zone application, you must use the composite video connections in addition to any S-Video connections. Only video sources connected with composite connectors can be viewed in the second zone (Zone B).

You must use the analog audio cable connections. (Digital inputs are not sent to Zone B.)

## Making Connections

This section describes how to connect speakers in the two zones to support the different scenarios. Before you read this section, Kenwood recommends reading “Connecting

Your Speakers” on page 4 of this manual. In addition, this section discusses how to connect a second TV/Monitor and how to connect an IR Receiver and IR Repeaters.

### Scenario 1: Surround Sound in Zone A only/Stereo in Zone A and Stereo in Zone B (Using the Receiver’s Speaker B Outputs)

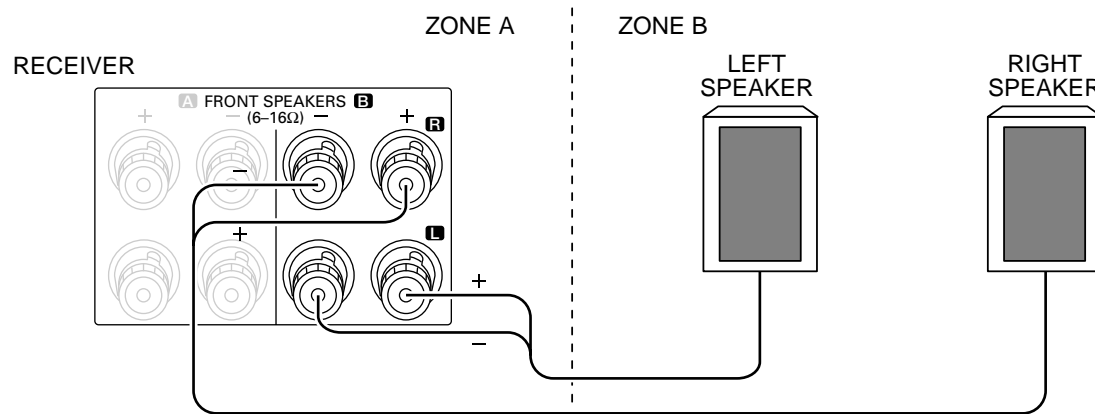

The five amplifiers built into the receiver meet your sound needs for both zones. The built-in amplifiers allow you to listen to full surround sound if you are listening in Zone A only, or stereo in Zone A if both zones are active. You will always hear stereo in Zone B. Make the speaker connections as shown in the illustration under “To Connect Front and Surround Sound Speakers:” on page 5, being sure to also connect the Zone B speakers to the **SPEAKER B** binding post.

### Scenario 2: Surround Sound in Zone A and Stereo in Zone B (Using a Stereo Amplifier in Zone B)

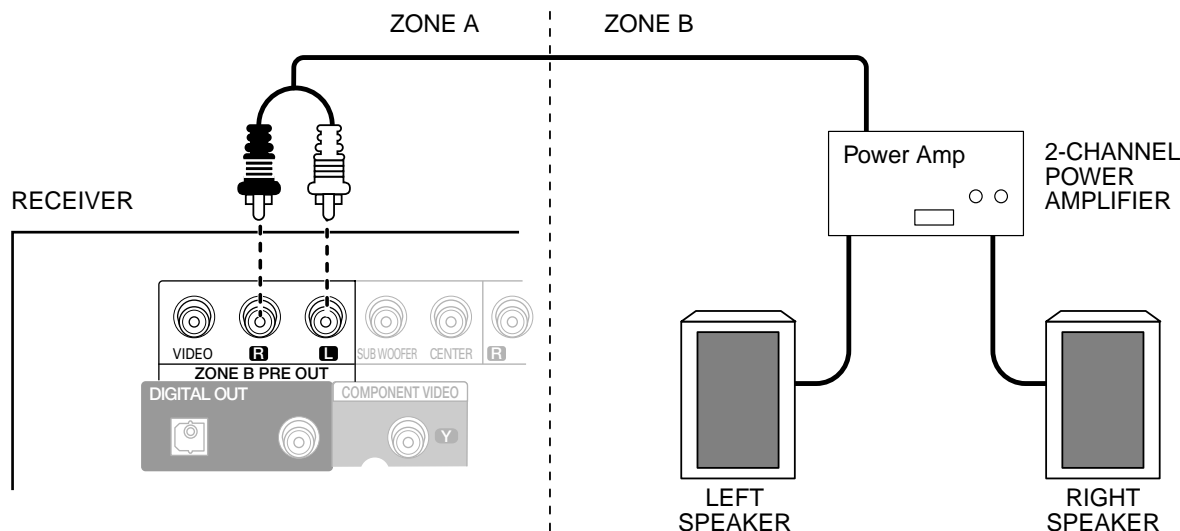

You use an additional stereo amplifier for Zone B. This allows you to listen to full surround sound in Zone A even if both zones are active. You will always hear stereo in Zone B. Make the speaker and amplifier connections as shown in the illustration.

### Both Scenarios: Connecting a Second TV/Monitor

If you plan to watch movies, or any other visual entertainment activity in Zone B, you must connect an additional TV/Monitor. To do so, connect a standard composite video cable from the Zone B TV to the ZONE B PRE OUT VIDEO jack.

The above is possible only when the composite signals are input.

## Connecting the External Infrared Receivers and IR Repeaters

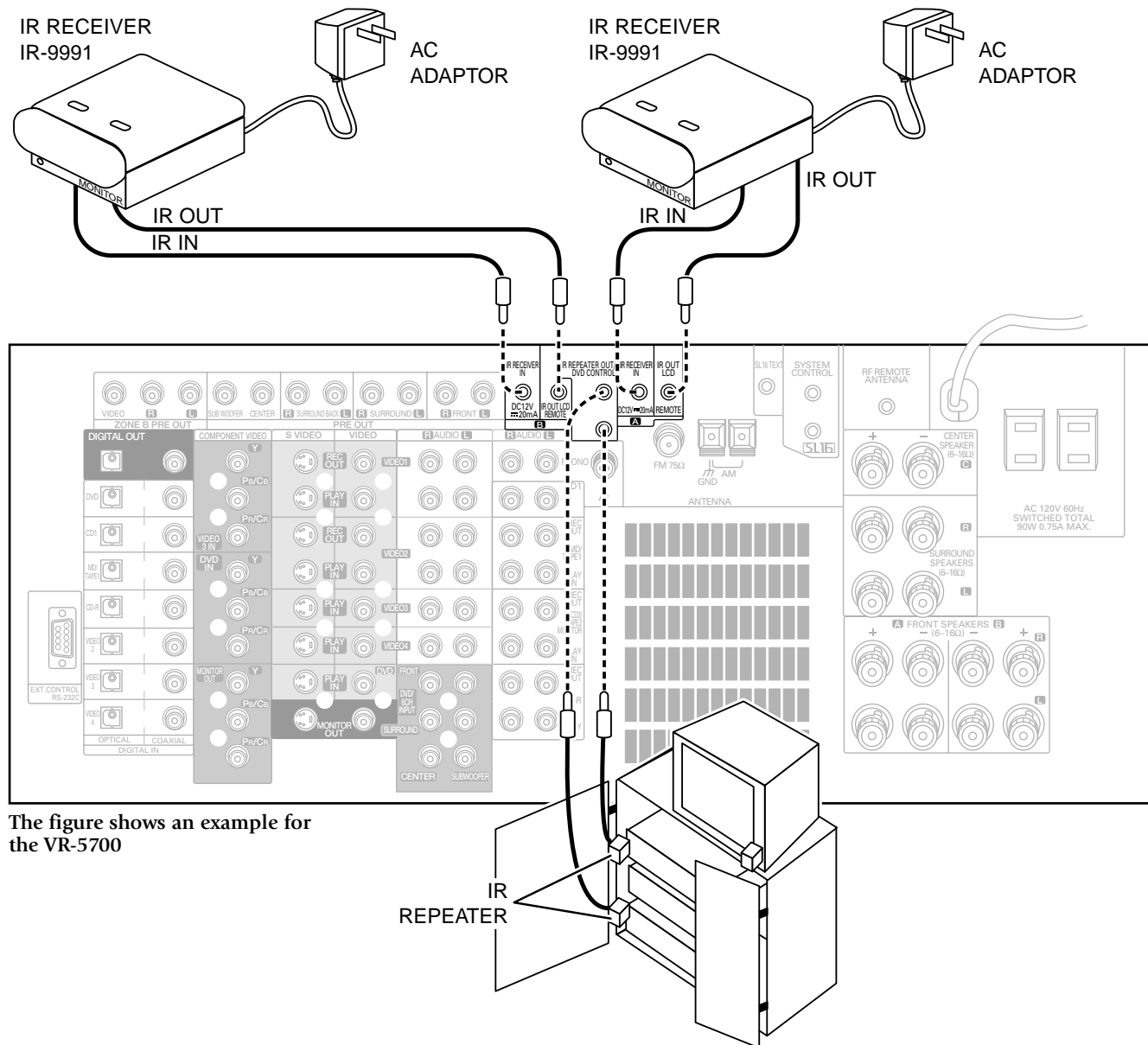

The figure shows an example for the VR-5700

## Connecting the External Infrared Receivers and IR Repeaters, continued

For any situation where you want to control the VR-5700/VR-5090/VR-5080 via IR (such as in a dual-zone system, or if there is extreme RF interference), you can connect an external IR transceiver to the VR-5700/VR-5090/VR-5080 and use Remote Control unit's IR communication instead of RF.

Kenwood's optional IR-9991 IR transceiver supports Remote Control unit's 2-way communication and will supply system status feedback to Remote Control unit. You can substitute Xantech (291-80, 480-30 or 490-30 series) IR receivers for the IR-9991, however these devices are one-way only, and will not supply system status feedback to Remote Control unit.

### To connect a Kenwood IR-9991 IR Transceiver

1. Connect the IR-9991's IR IN cable to the receiver's **B IR RECEIVER IN** jack. This jack supports a 12V 20 mA signal.
2. Connect the IR-9991's IR OUT cable to the receiver's **B IR OUT LCD REMOTE** jack.
3. Connect the IR-9991's power supply to it, but **do not** plug the power supply into an AC outlet until all connections have been made to the receiver.

### To connect any other IR Receiver

1. Connect the IR receiver's output cable to the VR-5700, VR-5090 or VR-5080's **B IR RECEIVER IN** jack. This jack supports a 12V 20mA signal.
2. If required, connect the IR receiver's power supply to it, but do not plug the power supply into an AC outlet until all connections have been made to the VR-5700, VR-5090 or VR-5080.

If you already have an IR transceiver or repeater connected to the **B IR RECEIVER** jacks and you need to install a second IR transceiver or repeater to substitute for the VR-5700, VR-5090 or VR-5080's front-panel IR receiver (such as if the VR-5700, VR-5090 or VR-5080 is mounted in a closet or cabinet), you can use the **A IR RECEIVER IN** and **A IR OUT LCD REMOTE** jacks. However, before using Remote control unit in this situation you must first turn the VR-5700, VR-5090 or VR-5080's RF receiver off.

### To turn the VR-5700, VR-5090 or VR-5080's RF Receiver off

- Press and hold the **RF ON/OFF (INPUT MODE)** button on the VR-5700, VR-5090 or VR-5080's front panel (behind the panel door) for more than 2 seconds. The display will read RF OFF.
- If the VR-5700, VR-5090 or VR-5080's RF receiver is off, you do not need to install the RF remote antenna. (See page 33.)

### To turn the VR-5700, VR-5090 or VR-5080's RF Receiver back on

- Press and hold the **RF ON/OFF (INPUT MODE)** button on the VR-5700, VR-5090 or VR-5080's front panel (behind the panel door) for more than 2 seconds. The display will read RF ON.

### To Connect IR Repeaters

IR repeaters enable you to control other devices that are located in cabinets or behind glass doors. To connect IR repeaters:

1. Connect the IR repeater to the device as described in the repeater's manual.
2. Connect the IR repeater cable(s) to the Receiver's **IR REPEATER OUT** jack(s).

IR repeaters send a signal similar to the device's own remote control. Xantech repeaters (models 282-00, 286-00, or 283-00) are compatible with your new audio-video receiver.

# Chapter Five: Warnings and Specifications

Read this page carefully to ensure safe operation.

## Warnings

### FCC WARNING

This equipment may generate or use radio frequency energy. Changes or modifications to this equipment may cause harmful interference unless the modifications are expressly approved in the instruction manual. The user could lose the authority to operate this equipment if an unauthorized change or modification is made.

**NOTE:** This equipment has been tested and found to comply with the limits for a Class B digital device, pursuant to Part 15 of the FCC Rules. These limits are designed to provide reasonable protection against harmful interference in a residential installation. This equipment may cause harmful interference to radio communications if it is not installed and used in accordance with the instructions. However, there is no guarantee that interference will not occur in a particular installation. If this equipment does cause harmful interference to radio or television reception, which can be determined by turning the equipment off and on, the user is encouraged to try to correct the interference by one or more of the following measures:

- Reorient or relocate the receiving antenna.
- Increase the separation between the equipment and the receiver.
- Connect the equipment into an outlet on a circuit different from the one that the receiver is connected to.
- Consult the dealer or an experienced radio/TV technician for help.

### FCC Compliance Notice

Audio-video Receiver, VR-5700, VR-5090 and VR-5080, and Remote Controller, RC-R0913

These devices comply with Part 15 of FCC Rules.

Operation is subject to the following two conditions: (1) This device may not cause harmful interference, and (2) this device must accept any interference received, including interference that may cause undesired operation.

KENWOOD U.S.A. CORPORATION

2201 East Dominguez St., Long Beach, CA 90801-5745

Telephone: 310-639-9000

### IC(Industry Canada) Notice

Operation is subject to the following two conditions: (1) This device may not cause interference, and (2) this device must accept any interference, including interference that may cause undesired operation of the device.

### Note to CATV System Installer:

This reminder is provided to call the CATV system installer's attention to Article 820-40 of the NEC that provides guidelines for proper grounding and, in particular, specifies that the cable ground shall be connected to the grounding system of the building, as close to the point of cable entry as practical.

**NOTE:** Do not use contact cleaning agents because they could cause a malfunction. Be especially careful not to use contact cleaning agents containing oil, since they may deform the plastic components.



Kenwood follows a policy of continuous advancements in development. For this reason, specifications may be changed without notice.

Full performance may not be exhibited in extremely cold locations (below 0 deg. C).

## VR-5700 Specifications

### Audio Section

#### Rated Output Power during stereo operation

120 watts per channel minimum RMS, both channels driven, at 6  $\Omega$  from 20Hz to 20kHz with no more than 0.03% total harmonic distortion (FTC).

#### Effective Output Power during surround operation

1 kHz, 0.06% T.H.D. at 6  $\Omega$ , all channel driven (Front, Center, Surround) ..... 120 W  $\times$  5

Total Harmonic Distortion ..... 0.005 % (1 kHz, 60 W, 6  $\Omega$ )

#### Frequency Response (IHF'66)

Line (CD1, MD/TAPE, CD2/TAPE2 MONITOR, CD-R, VIDEO 1 - 4, DVD/6CH.) ..... 7 Hz  $\sim$  100 kHz, 0 dB, -3 dB

#### Signal to Noise Ratio (IHF '66)

PHONO (MM) ..... 76 dB  
CD1 ..... 98 dB

#### Input Sensitivity / Impedance

PHONO (MM) ..... 4.0 mV / 47 k $\Omega$   
CD1 ..... 300 mV / 47 k $\Omega$   
DVD/6CH. .... 300 mV / 47 k $\Omega$

#### Output Level / Impedance

TAPE REC ..... 300 mV / 2.2 k $\Omega$   
PRE OUT (Front, Center, Surround, Surround back) ..... 1 V / 470  $\Omega$   
PRE OUT (Subwoofer) ..... 1.8 V / 470  $\Omega$

#### Tone Control

Bass .....  $\pm$  7 dB (at 100 Hz)  
Treble .....  $\pm$  7 dB (at 10 kHz)

#### Loudness Control

Volume at -30 dB level ..... +6 dB (100 Hz), +3 dB (10 kHz)

### Digital Audio Section

Sampling Frequency ..... 32 kHz, 44.1 kHz, 48 kHz, 96 kHz  
Input Level / Impedance / Wavelength

Optical ..... -15 dBm  $\sim$  -21 dBm, 660 nm  $\pm$ 30 nm  
Coaxial ..... 0.5 Vp-p / 75  $\Omega$

#### Output Level / Impedance / Wavelength

Optical ..... -15 dBm  $\sim$  -21 dBm, 660 nm  $\pm$ 30 nm  
Coaxial ..... 0.5 Vp-p / 75  $\Omega$



## Chapter Five : Warnings and Specifications

### Video Section

#### Video Inputs / Outputs

Video (composite) .....	1 Vp-p / 75 Ω
S Video (luminance signal) .....	1 Vp-p / 75 Ω
(chrominance signal) .....	0.286 Vp-p / 75 Ω
Component (luminance signal) .....	1 Vp-p / 75 Ω
(Pb/Pr-signal) .....	±0.324 Vp-p / 75 Ω

### FM Tuner Section

**Tuning Frequency Range** ..... 87.5 MHz ~ 108 MHz

#### Usable Sensitivity (Mono)

..... 1.2 μV (75 Ω) / 12.2 dBf (75 kHz dev., sinad 30 dB)

#### 50dB Quieting Sensitivity

Stereo ..... 22.4 μV (75Ω) / 38.2 dBf

#### Total Harmonic Distortion (1 kHz)

Mono ..... 0.3 % (71.2 dBf input)

Stereo ..... 0.5 % (71.2 dBf input)

#### Signal to Noise Ratio (1 kHz, 75 kHz DEV.)

Mono ..... 75 dB (71.2 dBf input)

Stereo ..... 70 dB (71.2 dBf input)

**Stereo Separation (1 kHz)** ..... 40 dB

**Selectivity (±400 kHz)** ..... 70 dB

**Frequency Response** ..... 30 Hz ~ 15 kHz, +0.5 dB, -3.0 dB

### AM Tuner Section

#### Tuning Frequency Range

10kHz step ..... 530 kHz ~ 1,700 kHz

#### Usable Sensitivity (30 % mod., S/N 20 dB)

..... 16 μV / (500 μV/m)

**Signal to Noise Ratio (30 % mod. 1 mV input)** ..... 50 dB

### IR In/Out Section

#### IR Receiver In Terminal

Maximum Output Current ..... 20mA

Operating Voltage ..... 12V

Output Impedance ..... 470Ω

#### IR Out LCD Remote Terminal

Maximum Output Current ..... 20mA

Operating Voltage ..... 5V

Output Impedance ..... 470Ω

#### IR Repeater Out Terminal

Maximum Output Current ..... 20mA

Operating Voltage ..... 12V

Output Impedance ..... 470Ω

SHAPE OF PLUG TO BE CONNECTED:

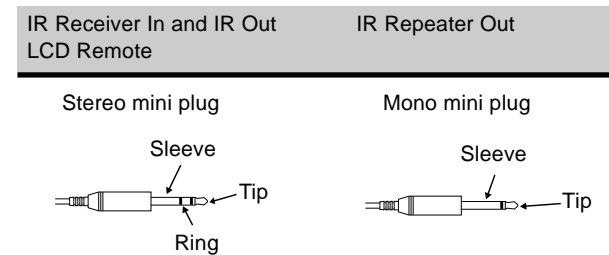

IR IN/OUT SPECIFICATION:

Terminal	IR Receiver In	IR Out LCD Remote
To Tip	Signal	Signal
To Ground	Ground	—
To Sleeve	+12V	Ground

### General

**Power consumption** ..... 6.2 A

**AC outlet Switched** ..... 2 (total 90W, 0.75 A max.)

**Dimensions** ..... W: 440mm (17-5/16")

..... H: 191mm (7-1/2")

..... D: 416mm (16-3/8")

**Weight (Net)** ..... 18.2kg (40.1lb)

## VR-5090/VR-5080 Specifications

### Audio Section

#### Rated Output Power during stereo operation

110 watts per channel minimum RMS, both channels driven, at 6 Ω from 20Hz to 20kHz with no more than 0.03% total harmonic distortion (FTC).

#### Effective Output Power during surround operation

1 kHz, 0.06% T.H.D. at 6 Ω, all channel driven (Front, Center, Surround) ..... 80 W × 5

**Total Harmonic Distortion** ..... 0.005 % (1 kHz, 55 W, 6 Ω)

#### Frequency Response (IHF'66)

VR-5090

Line (CD1, MD/TAPE, CD2/TAPE2 MONITOR, CD-R, VIDEO 1 - 4, DVD/6CH.) ..... 7 Hz ~ 100 kHz, 0 dB, -3 dB

VR-5080

Line (CD1, MD/TAPE, CD2/TAPE2 MONITOR, CD-R, VIDEO 1 - 3, DVD/6CH.) ..... 7 Hz ~ 100 kHz, 0 dB, -3 dB

#### Signal to Noise Ratio (IHF '66)

PHONO (MM) ..... 76 dB

CD1 ..... 98 dB

#### Input Sensitivity / Impedance

PHONO (MM) ..... 4.0 mV / 47 kΩ

CD1 ..... 300 mV / 47 kΩ

DVD/6CH ..... 300 mV / 47 kΩ

#### Output Level / Impedance

TAPE REC ..... 300 mV / 2.2 kΩ

PRE OUT (Front, Center, Surround, Surround back)

..... 1 V / 470 Ω

PRE OUT (Subwoofer) ..... 1.8 V / 470 Ω

#### Tone Control

Bass ..... ± 7 dB (at 100 Hz)

Treble ..... ± 7 dB (at 10 kHz)

#### Loudness Control

Volume at -30 dB level ..... +6 dB (100 Hz), +3 dB (10 kHz)

### Digital Audio Section

**Sampling Frequency** ..... 32 kHz, 44.1 kHz, 48 kHz, 96 kHz

#### Input Level / Impedance / Wavelength

Optical ..... -15 dBm ~ -21 dBm, 660 nm ±30 nm

Coaxial ..... 0.5 Vp-p / 75 Ω

#### Output Level / Impedance / Wavelength

VR-5090

Optical ..... -15 dBm ~ -21 dBm, 660 nm ±30 nm

Coaxial ..... 0.5 Vp-p / 75 Ω

VR-5080

Optical ..... -15 dBm ~ -21 dBm, 660 nm ±30 nm

## Chapter Five : Warnings and Specifications

### Video Section

#### Video Inputs / Outputs

Video (composite) .....	1 Vp-p / 75 Ω
S Video (luminance signal) .....	1 Vp-p / 75 Ω
(chrominance signal) .....	0.286 Vp-p / 75 Ω
Component (luminance signal) .....	1 Vp-p / 75 Ω
(Pb/Pr-signal) .....	±0.324 Vp-p / 75 Ω

### FM Tuner Section

**Tuning Frequency Range** ..... 87.5 MHz ~ 108 MHz

#### Usable Sensitivity (Mono)

..... 1.2 μV (75 Ω) / 12.2 dBf (75 kHz dev., sinad 30 dB)

#### 50dB Quieting Sensitivity

Stereo ..... 22.4 μV (75Ω) / 38.2 dBf

#### Total Harmonic Distortion (1 kHz)

Mono ..... 0.3 % (71.2 dBf input)

Stereo ..... 0.5 % (71.2 dBf input)

#### Signal to Noise Ratio (1 kHz, 75 kHz DEV.)

Mono ..... 75 dB (71.2 dBf input)

Stereo ..... 70 dB (71.2 dBf input)

52

**Stereo Separation (1 kHz)** ..... 40 dB

**Selectivity (±400 kHz)** ..... 70 dB

**Frequency Response** ..... 30 Hz ~ 15 kHz, +0.5 dB, -3.0 dB

### AM Tuner Section

#### Tuning Frequency Range

10kHz step ..... 530 kHz ~ 1,700 kHz

#### Usable Sensitivity (30 % mod., S/N 20 dB)

..... 16 μV / (500 μV/m)

**Signal to Noise Ratio (30 % mod. 1 mV input)** ..... 50 dB

### IR In/Out Section

#### IR Receiver In Terminal

Maximum Output Current ..... 20mA

Operating Voltage ..... 12V

Output Impedance ..... 470Ω

#### IR Out LCD Remote Terminal

Maximum Output Current ..... 20mA

Operating Voltage ..... 5V

Output Impedance ..... 470Ω

#### IR Repeater Out Terminal

Maximum Output Current ..... 20mA

Operating Voltage ..... 12V

Output Impedance ..... 470Ω

#### SHAPE OF PLUG TO BE CONNECTED:

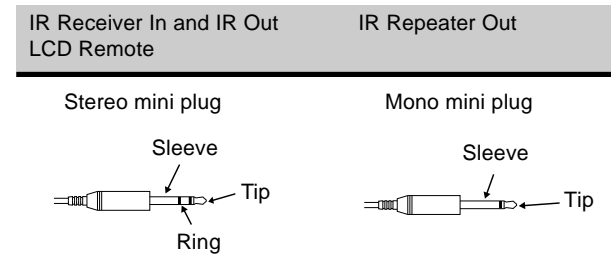

#### IR IN/OUT SPECIFICATION:

Terminal	IR Receiver In	IR Out LCD Remote
To Tip	Signal	Signal
To Ground	Ground	—
To Sleeve	+12V	Ground

### General

**Power consumption** ..... 5 A

**AC outlet Switched** ..... 2 (total 90W, 0.75 A max.)

**Dimensions** ..... W: 440mm (17-5/16")

..... H: 191mm (7-1/2")

..... D: 416mm (16-3/8")

**Weight (Net)** ..... 15.0 kg (33.0 lb)

## Numerics

- 200-Disc CD Changer
  - connecting ..... 17
  - connecting SL16 text cable ..... 17
  - identifying for Remote Control unit ..... 39
  - SL16/XS8 switch ..... 17

## A

- AM antenna
  - connecting ..... 33
  - preventing hum interference ..... 33
- amplifier
  - connecting ..... 6, 8
  - using in multiple zones ..... 47
- analog cables
  - DVD player ..... 19
  - laser disc player ..... 26, 28
  - using in multiple zones ..... 46
- antennas, connecting ..... 33
- audio cables
  - 200-Disc CD Changer ..... 17
  - cable TV ..... 12
  - camcorder ..... 31
  - CD player ..... 16
  - CD-R recorder ..... 20
  - DVD player ..... 18
  - laser disc player (AC-3 Output) ..... 26
  - laser disc player (no AC-3 Output) ..... 28
  - MD recorder ..... 22
  - primary CD player ..... 16
  - primary tape deck ..... 22
  - satellite tuner ..... 12
  - secondary CD player ..... 24
  - second tape deck ..... 24
  - TV ..... 10
  - VCR ..... 14, 31

## B

- batteries, installing in Remote Control unit ... 34
- bass peak level ..... 38

## C

- cable radio, connecting (call provider) ..... 33
- cable TV
  - connecting ..... 12
  - identifying for Remote Control unit ..... 39
  - with RCA video output ..... 13
  - without RCA video output ..... 13
- camcorder, connecting ..... 31

- CD player, connecting ..... 16
  - identifying to Remote Control unit ..... 39
- CD-R Recorder, connecting ..... 20
  - identifying to Remote Control unit ..... 39
- center speaker, connecting ..... 4, 8
- coaxial cable
  - 200-Disc CD Changer ..... 17
  - cable TV ..... 12
  - CD player ..... 16
  - CD-R recorder ..... 20
  - DVD player ..... 18
  - LD player ..... 26, 28
  - MD recorder ..... 22
  - satellite tuner ..... 12
- communication cable, connecting ..... 16
- component video cable
  - cable TV ..... 12
  - DVD player ..... 18
  - satellite tuner ..... 12
  - TV ..... 10
- connecting
  - 200-Disc CD Changer ..... 17
  - AM antenna ..... 33
  - amplifier ..... 6, 8, 47
  - antennas ..... 33
  - audio cable to MD recorder ..... 22
  - audio cables to VCR ..... 14
  - cable radio (call provider) ..... 33
  - camcorder ..... 31
  - CD player ..... 16
  - CD-R Recorder ..... 20
  - DVD player ..... 18
  - external infrared receiver ..... 48
  - FM antenna ..... 33
  - IR repeaters ..... 48
  - laser disc player with AC-3 Output ..... 26
  - MD recorder ..... 22
  - other primary CD player ..... 17
  - primary tape deck ..... 22
  - second VCR ..... 15
  - speakers ..... 4, 6
  - speakers multiple zones ..... 47
  - system control cable to primary
    - tape deck ..... 22
  - tape deck ..... 22
  - turntable/record player ..... 30
  - turntable's ground cable to receiver ..... 30
  - TV ..... 10, 47
  - VCR ..... 14, 31
  - video cables to VCR ..... 14

- video-CD compatible CD player ..... 17
- connection warning
  - analog cables, laser disc player ..... 27, 29
  - DVD player ..... 19
  - laser disc player ..... 27, 29
  - second CD player ..... 25
  - second tape deck ..... 25

## D

- deleting, Remote Control unit setup codes ..... 40
- devices
  - identifying for Remote Control unit ..... 39
- digital cable
  - 200-Disc CD Changer ..... 17
  - cable TV ..... 12
  - CD player ..... 16
  - CD-R recorder ..... 20
  - DVD player ..... 18
  - LD player ..... 26, 28
  - MD recorder ..... 22
  - satellite tuner ..... 12
- Dolby Digital (AC-3) RF Out ..... 27
- DVD player
  - connecting ..... 18
  - identifying for Remote Control unit ..... 39

## E

- external infrared receiver, connecting ..... 48

## F

- FM antenna, connecting ..... 33
- front speakers, connecting ..... 5

## G

- ground cable, connecting turntable ..... 30

## H

- hum interference ..... 33

## I

- IR receiver
  - connecting ..... 48
  - models compatible with receiver ..... 49
- IR repeaters
  - connecting ..... 48
  - models compatible with receiver ..... 49

## L

- laser disc player
  - identifying for Remote Control unit ..... 39
  - RF Demodulator ..... 26
  - with AC-3 Output, connecting ..... 26
  - with PCM Digital Output, connecting ..... 28
  - without AC-3 Output, connecting ..... 28
  - without Dolby Digital Output,
    - connecting ..... 28
- left speakers
  - front, connecting ..... 4
  - surround, connecting ..... 4, 6

## M

- MD recorder, connecting ..... 22
  - identifying to Remote Control unit ..... 39
- multiple zones
  - connecting IR repeaters ..... 48
  - connecting second TV monitor ..... 47
  - IR receiver, connecting ..... 48
  - sound scenarios ..... 47
  - using external infrared receiver ..... 48

## O

- optical cable
  - 200-Disc CD Changer ..... 17
  - cable TV ..... 12
  - CD player ..... 16
  - CD-R recorder ..... 20
  - DVD player ..... 18
  - LD player ..... 26, 28
  - MD recorder ..... 22
  - satellite tuner ..... 12

## P

- powered subwoofer, connecting ..... 6

## R

- record player/turntable, connecting ..... 30
- Remote Control unit
  - clearing stored settings and
    - reconfiguring ..... 34
  - deleting setup code ..... 40
  - identifying components ..... 39
  - installing batteries ..... 34
  - operating components through
    - external infrared receiver ..... 48
  - replacing old setup code with new ..... 40
  - resetting ..... 34

- selecting speakers ..... 36
  - speaker distance, setting ..... 38
  - speaker level, setting ..... 37
  - speaker type, setting ..... 36
  - subwoofer level, setting ..... 38
  - RF remote antenna ..... 33
  - RF remote control function ..... 43
  - right speakers
    - front, connecting ..... 4
    - surround, connecting ..... 4, 6
  - RS-232C connector ..... 2
- S**
- S video cable
    - cable TV ..... 12
    - DVD player ..... 18
    - laser disc player ..... 26, 28
    - satellite tuner ..... 12
    - TV ..... 10
    - VCR ..... 14
  - satellite tuner
    - connecting ..... 12
    - identifying for Remote Control unit ..... 39
  - second tape deck
    - connecting ..... 23
    - connecting audio cable ..... 23
    - connection warning ..... 25
    - identifying for Remote Control unit ..... 39
  - second VCR
    - connecting ..... 15
    - identifying for Remote Control unit ..... 39
- SL16**
- 200-Disc CD Changer ..... 16
  - chained connections ..... 32
  - system control mode ..... 32
  - XS8 switch, 200-Disc CD Changer ..... 17
- sound level meter** ..... 42
- sound scenarios**
- Zone A ..... 47
  - Zone B ..... 47
- speakers**
- connecting ..... 4, 6, 47
  - connecting in multiple zones ..... 47
  - setting with Remote Control unit ..... 36
- specifications and warnings** ..... 50
- subwoofer**
- connecting ..... 6
- supplemental power amplifiers, connecting** ..... 8
- surround sound**
- connecting speakers ..... 4, 6
- system control cables**
- 200-Disc CD Changer ..... 17
  - CD player ..... 16
  - connection warning ..... 32
  - MD recorder ..... 22
  - tape deck ..... 22
- system control chaining** ..... 32
- setup codes**
- deleting ..... 40
- THX speaker** ..... 37
- turntable/record player, connecting** ..... 30
- TV**
- connecting ..... 10
  - identifying for Remote Control unit ..... 39
  - watching without using receiver ..... 11
- V**
- VCR**
- connecting ..... 14
  - identifying for Remote Control unit ..... 39
- video cables**
- cable TV ..... 12
  - camcorder ..... 31
  - DVD player ..... 18
  - laser disc player (AC-3 Output) ..... 26
  - laser disc player (no AC-3 Output) ..... 28
  - satellite tuner ..... 12
  - TV ..... 12
  - VCR ..... 14
- video CD-compatible CD player, connecting** ... 17
- W**
- warnings and specifications ..... 50
- Z**
- zone A
    - sound scenario ..... 47
  - zone B
    - connecting second TV ..... 47
    - sound scenario ..... 47

# KENWOOD

## For your records

Record the serial number, found on the back of the unit, in the spaces designated on the warranty card, and the space provided below. Refer to the model and serial numbers whenever you call upon your dealer for information or service on this product.

Model \_\_\_\_\_ Serial Number \_\_\_\_\_